



airFiber[®] 5X

5 GHz Carrier
Backhaul Radio

Model: AF-5X

USER GUIDE

Table of Contents

Chapter 1: Overview	1
Introduction	1
Package Contents	1
airFiber Configuration Interface System Requirements	1
Hardware Overview	1
Chapter 2: Installation	3
Installation Requirements	3
Installation Overview	3
Connecting Power over Ethernet	3
airFiber Configuration	4
Hardware Installation	5
Alignment	9
Installer Compliance Responsibility	10
Chapter 3: Navigation	11
Accessing the airFiber Configuration Interface	11
Product Verification	12
Interface Tabs	12
Chapter 4: Main Tab	13
Status	13
Ethernet	15
Monitor	15
Chapter 5: Wireless Tab	16
Basic Wireless Settings	16
Frequency Settings	17
Wireless Security	18
Chapter 6: Network Tab	19
Management Network Settings	19
Chapter 7: Advanced Tab	21
Wireless Settings	21
DATA Port Ethernet Settings	21
MGMT Port Ethernet Settings	23

Chapter 8: Services Tab	24
Ping Watchdog	24
SNMP Agent	25
Telnet Server	26
NTP Client	26
Dynamic DNS	26
System Log	26
Device Discovery	26
Chapter 9: System Tab	27
Firmware Update	27
Device	28
Date Settings	28
System Accounts	28
Miscellaneous	28
Location	29
Device Maintenance	29
Configuration Management	29
Chapter 10: Tools	30
Align Antenna	30
Discovery	31
Ping	31
Traceroute	31
airView	31
Appendix A: Specifications	35
Appendix B: Safety Notices	36
Electrical Safety Information	36
Appendix C: Warranty	37
Limited Warranty	37
Appendix D: Compliance Information	39
Installer Compliance Responsibility	39
FCC	39
Industry Canada	39
RF Exposure Warning	40
Australia and New Zealand	40
CE Marking	40
Frequency Ranges and Power Levels per Country/Region	41
RoHS/WEEE Compliance Statement	44

Appendix E: Declaration of Conformity	45
Appendix F: Contact Information	46
Ubiquiti Networks Support	46

Chapter 1: Overview

Introduction

Thank you for purchasing the Ubiquiti Networks® airFiber® AF-5X 5 GHz Carrier Backhaul Radio. This User Guide is for use with airFiber model AF-5X, and provides installation instructions, explains how to set up an airFiber link, and shows how to access and use the airFiber Configuration Interface.

Package Contents

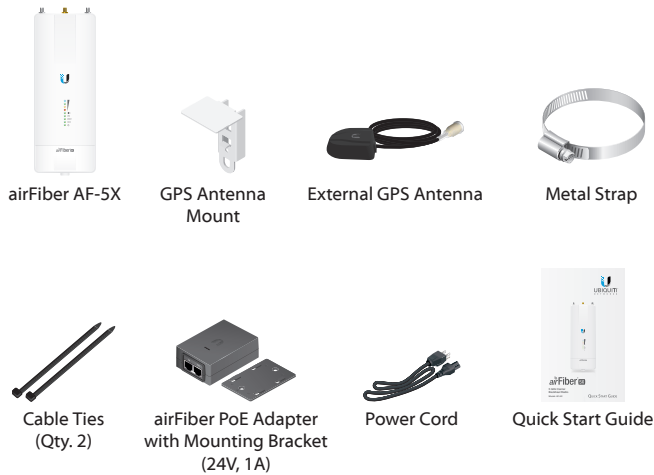

TERMS OF USE: Ubiquiti radio devices must be professionally installed. Shielded Ethernet cable and earth grounding must be used as conditions of product warranty. TOUGH Cable™ is designed for outdoor installations. It is the customer's responsibility to follow local country regulations, including operation within legal frequency channels, output power, and Dynamic Frequency Selection (DFS) requirements.

airFiber Configuration Interface System Requirements

- Microsoft Windows 7, Windows 8; Linux; or Mac OS X
- Java Runtime Environment 1.6 (or above)
- Web Browser: Mozilla Firefox, Apple Safari, Google Chrome, or Microsoft Internet Explorer 8 (or above)

Hardware Overview

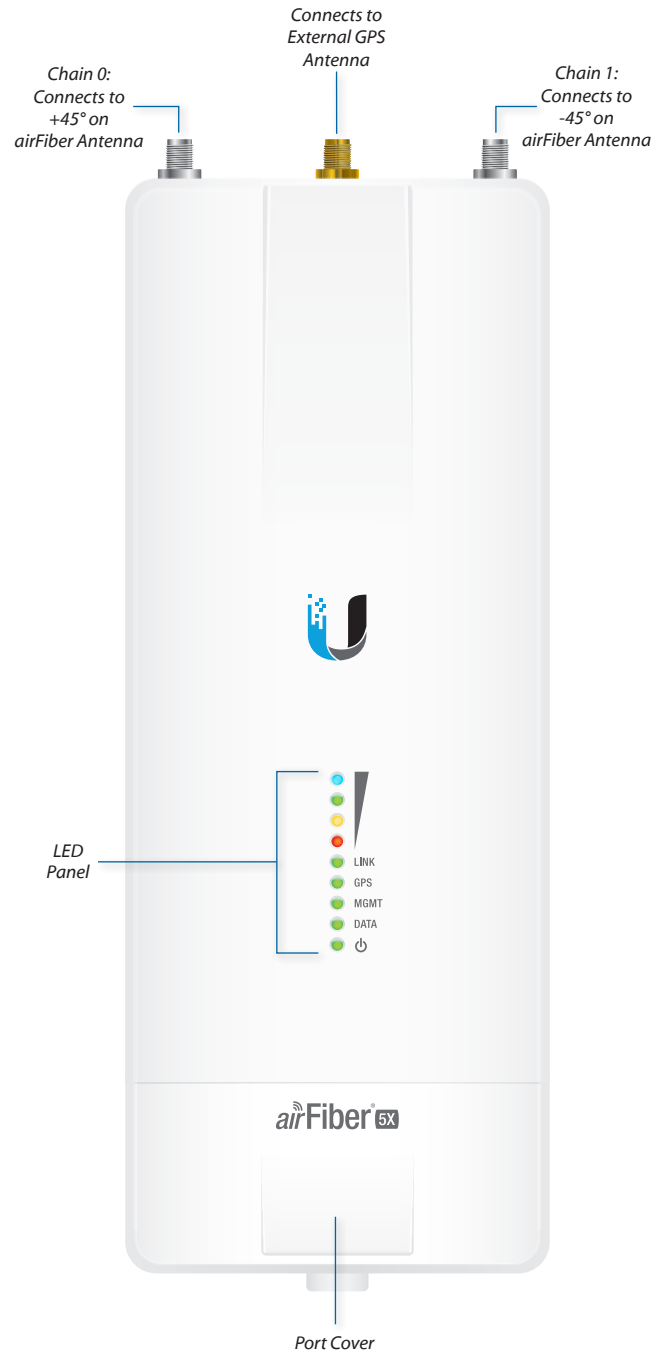

Ports

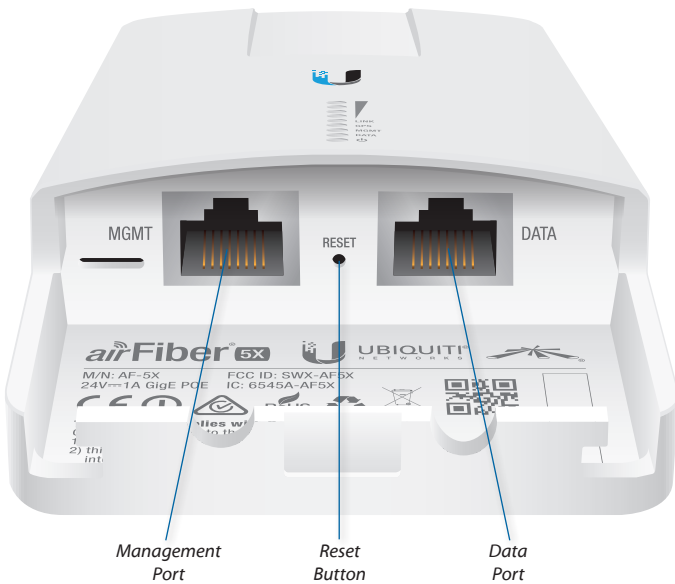





Management Port 10/100 Mbps, secured Ethernet port for configuration. *In-Band Management* is enabled by default in the airFiber Configuration Interface. When *In-Band Management* is disabled, the *MGMT* port is the only port that can monitor, configure, and/or update firmware.

Reset Button To reset to factory defaults, press and hold the *Reset* button for more than 10 seconds while the device is already powered on.

Data Port Gigabit PoE port for handling all user traffic and powering the device.

LEDs

Signal LEDs

-  **Signal 4** LED will light blue when on.
-  **Signal 3** LED will light green when on.
-  **Signal 2** LED will light yellow when on.
-  **Signal 1** LED will light red when on.

Bootup to airOS When powering on, the *Power*, *GPS*, *LINK*, and *Signal 1-4* LEDs light on. Once the CPU code takes over, the *GPS*, *LINK*, and *Signal 1-3* LEDs turn off. *Signal 4* LED remains on to indicate the boot sequence is underway.

Initializing airFiber Software When the airFiber application begins to boot under airOS, the *Signal 4* LED goes from solidly on to a 2.5 Hz flash. This continues until the AF-5X is fully booted.

Signal Level Once fully booted, the *Signal 1-4* LEDs act as a bar graph showing how close the AF-5X is to ideal aiming. This is auto-scaled based on the link range, the antenna gains, and the configured TX power of the remote AF-5X. Each *Signal* LED has three possible states: *On*, *Flashing*, and *Off*. All *Signal* LEDs would be solidly on in an ideal link. If the link has a 1 dB loss, the *Signal 4* LED will flash; a 2 dB loss and the *Signal 4* LED will turn off. The full bar graph LED states are shown below.

dB loss	0	-1	-2	-3	-4	-5	-6	-7	-8	-9	-10	-11	-12	-13
Signal 4 (Light Blue)	1	F	0	0	0	0	0	0	0	0	0	0	0	0
Signal 3 (Light Green)	1	1	1	F	0	0	0	0	0	0	0	0	0	0
Signal 2 (Light Yellow)	1	1	1	1	1	F	F	0	0	0	0	0	0	0
Signal 1 (Light Red)	1	1	1	1	1	1	1	1	1	1	F	F	F	0

0 = Off, 1 = On, F = Flashing

Additional LEDs

LED	State	Status
LINK	Off	RF Off
	Short Flash*	Syncing
	Normal Flash*	Beaconing
	Long Flash*	Registering
	On	Operational
GPS	Off	No GPS Synchronization
	Normal Flash*	Non-Operational (Weak Signal)
	On	Operational (Strong Signal)
MGMT	Off	No Ethernet Link
	On	Ethernet Link Established
	Random Flashing	Ethernet Activity
DATA	Off	No Ethernet Link
	On	Ethernet Link Established
	Random Flashing	Ethernet Activity
Power	Off	No Power
	On	Powered On

* Short Flash (1:3 on/off cycle)
 Normal Flash (1:1 on/off cycle)
 Long Flash (3:1 on/off cycle)

Chapter 2: Installation

Installation Requirements

The airFiber AF-5X radio operates only with an airFiber antenna or a retrofitted RocketDish™ antenna.

airFiber antenna models:

- AF-5G23-S45
- AF-5G30-S45
- AF-5G34-S45

Retrofit accessory for RocketDish (RD-5G30/RD-5G34):

- AF-5G-OMT-S45

See the antenna's Quick Start Guide for antenna installation instructions.

Other Requirements

- Clear line of sight between airFiber radios
- Clear view of the sky for proper GPS operation
- Vertical mounting orientation
- Mounting point:
 - At least 1 m below the highest point on the structure
 - For tower installations, at least 3 m below the top of the tower
- Ground wires – min. 10 AWG (5 mm²) and max. length: 1 m. As a safety precaution, ground the airFiber radio to grounded masts, poles, towers, or grounding bars.

WARNING: Failure to properly ground your airFiber radio will void your warranty.

- (Recommended) 2 Outdoor Gigabit PoE surge protectors

Note: For guidelines about grounding and lightning protection, follow your local electrical regulatory codes.

- Outdoor, shielded Category 6 (or above) cabling and shielded RJ-45 connectors are required for all wired Ethernet connections.

Installation Overview

We recommend that you configure your paired airFiber AF-5X radios before site installation. Below is an overview of the installation with specific details in the following instructions:

- Connect Power over Ethernet to the *DATA* port, and connect an Ethernet cable between your computer and the *MGMT* port.
- Configure the device settings in the airFiber Configuration Interface.
- Install a ground wire and mount the AF-5X on an airFiber compatible antenna.
- At the installation site, install the dish antenna (see the antenna's Quick Start Guide for installation instructions).
- Secure the ground wire and mount the GPS antenna.
- Establish and optimize the RF link.

Connecting Power over Ethernet

1. Lift the release latch on the bottom of the AF-5X and slide the *Port Cover* off.

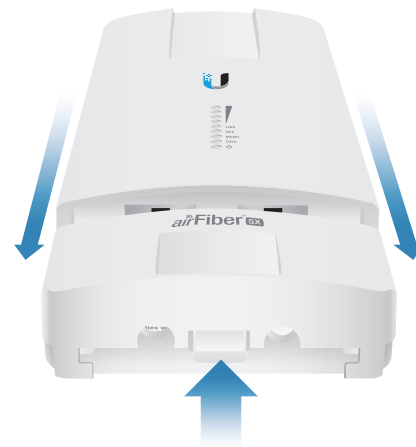

2. Connect an Ethernet cable to the *DATA* port.

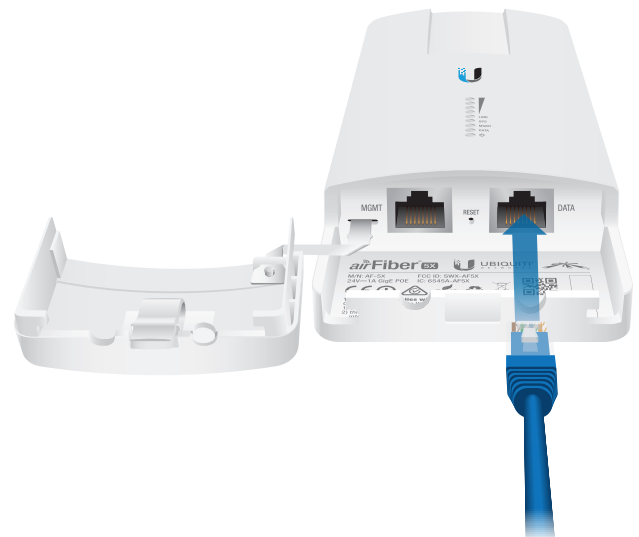

3. Connect the Ethernet cable from the *DATA* port to the Ethernet port labeled **POE** on the *airFiber PoE Adapter*.

WARNING: Use only the included airFiber PoE adapter, Model: **GP-H240-100G-4**. Failure to do so can damage the unit and void the product warranty.

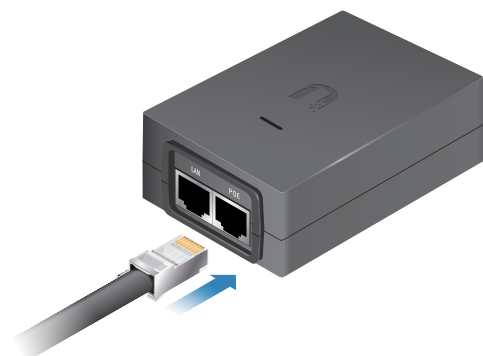

4. Connect the *Power Cord* to the power port on the *airFiber PoE Adapter*. Connect the other end of the *Power Cord* to a power source.

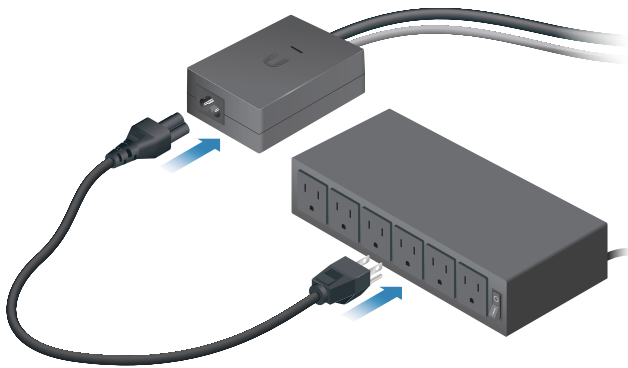

airFiber Configuration

The instructions in this section explain how to access the airFiber Configuration Interface and configure the following settings:

- **Wireless Mode** Configure one AF-5X as the *Master* and the other as the *Slave*.
- **Frequency Setting** The operating *Frequency* must be the same on both the Master and the Slave.

1. Connect an Ethernet cable from your computer to the *MGMT* port on the AF-5X.

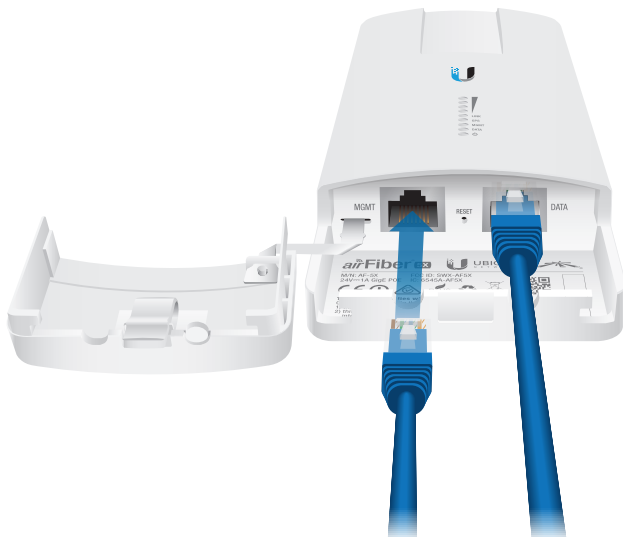

2. Configure the Ethernet adapter on your computer with a static IP address on the 192.168.1.x subnet.
3. Launch your web browser. Type **http://192.168.1.20** in the address field and press **enter** (PC) or **return** (Mac).



4. The login screen will appear. Enter **ubnt** in the *Username* and *Password* fields. Select your *Country* and *Language*. You must agree to the *Terms of Use* to use the product. Click **Login**.

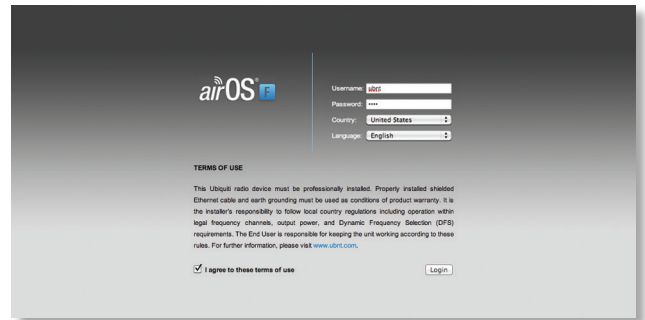

Note: U.S. product versions are locked to the U.S. Country Code to ensure compliance with FCC regulations.

5. The *Main* tab will appear. Click the **Tools** drop-down and select **Link Calculator**. This tool will guide you on how to best minimize bandwidth and power/interference issues.
6. Enter the requirements of your link, and then click **Calculate**. Adjust the values as needed to get the optimal result, and then write down the settings needed for your configuration.
7. Click the **Wireless** tab.

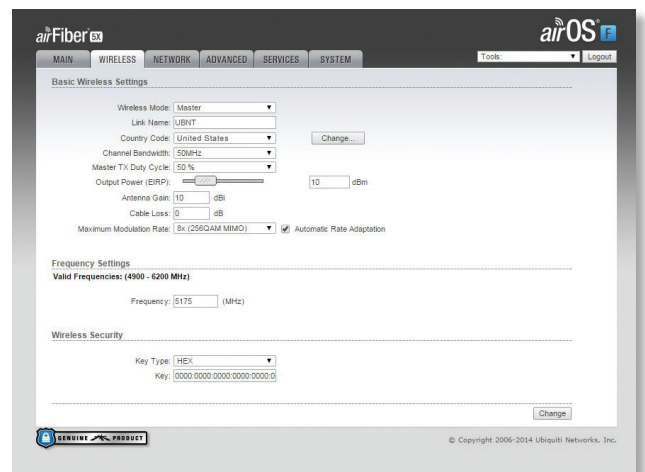

8. Configure the *Basic Wireless Settings*:
 - a. For one AF-5X, select **Master** as the *Wireless Mode*. For the other AF-5X, keep the default, *Slave*.
 - b. Enter a name in the *Link Name* field. This should be the same on both the Master and the Slave.
 - c. If needed, change the *Channel Bandwidth*, (*Master*) *Duty Cycle*, *Output Power* and/or *Maximum Modulation Rate* settings.
9. Configure the *Frequency Settings*. The selected *Frequency* must be the same on both airFiber radios.

10. Configure the *Wireless Security*:

- a. Select the *AES Key Type*, **HEX** or **ASCII**.
- b. For the *Key field*:
 - **HEX** Enter 16 bytes (eight, 16-bit HEX values: 0-9, A-F, or a-f). You can omit zeroes and use colons, similar to the IPv6 format.



Note: The airFiber Configuration Interface supports IPv6 formats excluding dotted quad and ":::" (double-colon) notation.

- **ASCII** Enter a combination of alphanumeric characters (0-9, A-Z, or a-z).
11. Click **Change** and then click **Apply**.
 12. *In-Band Management* is enabled by default, so each airFiber radio must have a unique *IP Address*. (If the airFiber radios use the same *IP Address*, you may lose access to the airFiber radios via the *DATA* ports.) Click the **Network** tab.

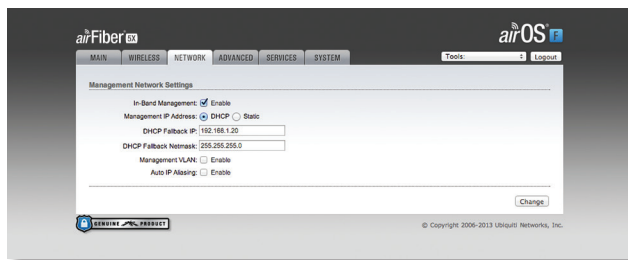

- a. For the *Management IP Address* option:
 - **DHCP** Keep the default, *DHCP*, to use DHCP reservation on your router to assign a unique *IP Address*.
 - **Static** Change the *IP Address*, *Netmask*, and other settings to make them compatible with your network.
- b. Click **Change** and then click **Apply**.

Repeat the instructions in the *airFiber Configuration* section on your other AF-5X. After you have configured the airFiber radios, disconnect them and move them to your installation site.

Hardware Installation

Install a Ground Wire

1. Remove the nut from the *Ground Bonding Point* located on the back of the AF-5X.

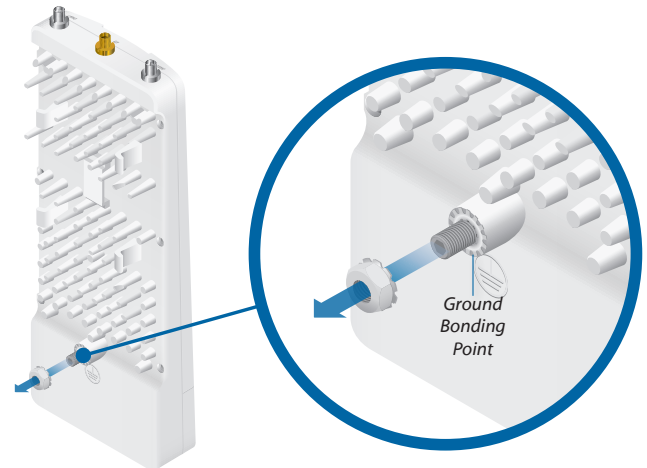

2. Attach a ground wire (min. 10 AWG or 5 mm²) to the lug and replace the nut to secure the wire.

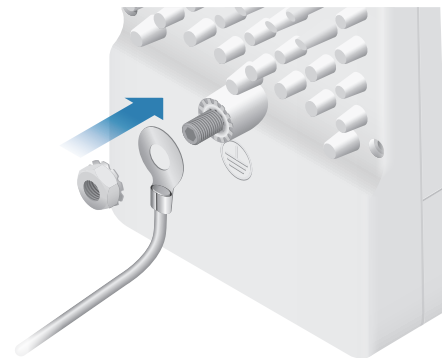

3. At the installation site, secure the other end of the ground wire to a grounded mast, pole, tower, or grounding bar.



WARNING: Failure to properly ground your airFiber radio will void your warranty.



Note: The ground wire should be as short as possible and no longer than one meter in length.

Mount to an Antenna

The AF-5X can be mounted to an airFiber antenna or a retrofitted RocketDish. The airFiber Dish Antenna (AF-5G30-S45) is shown in the following steps:

1. Attach the AF-5X to the mounting bracket.
 - a. Align the mounting tabs on the back of the AF-5X with the mounting bracket.
 - b. Slide the AF-5X down to lock it into place.

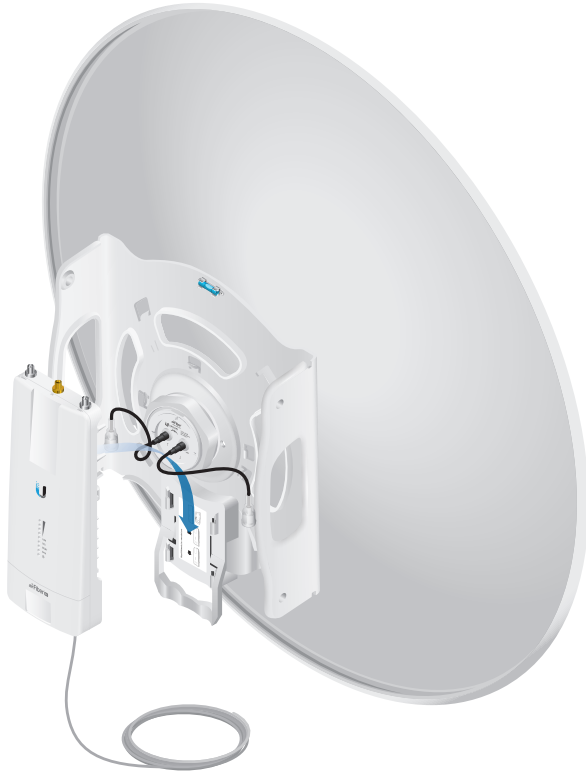

2. Attach the RF cables from the antenna feed to the RF connectors on the AF-5X in this combination: +45° to Chain 0 and -45° to Chain 1.



3. Attach the *External GPS Antenna* to the RF connector labeled *GPS*. Then, place the magnetic *External GPS Antenna* on the bracket (this is temporary; you will mount the *External GPS Antenna* on the *GPS Antenna Mount* at the site).



4. Attach the protective shroud.
 - a. Align the hash mark on the top of the shroud with the notch on the dish antenna.
 - b. Rotate the shroud clockwise until it locks into place.



Mount the External GPS Antenna

Locate a mounting point that has a clear view to the sky, and is above and as far away as possible from the AF-5X.

1. Attach the *GPS Antenna Mount* to the pole using the metal strap, or attach it to a wall using the appropriate fasteners (not included).

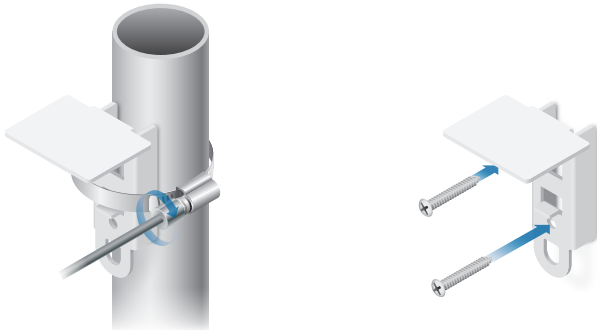

2. Place the *External GPS Antenna* on the mount.

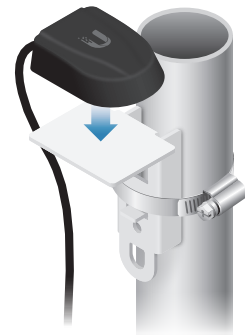

3. Secure the cable of the *External GPS Antenna* to the mount with a *Cable Tie*.



Connecting Power over Ethernet

1. Lift the release latch on the bottom of the AF-5X and slide the *Port Cover* off.

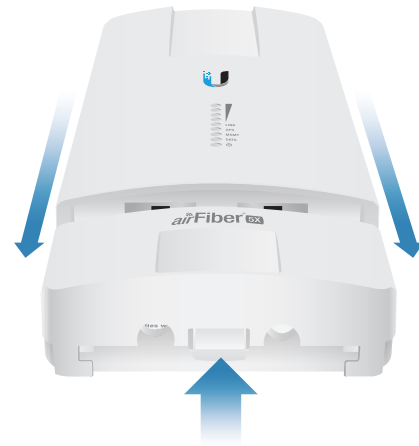

2. Connect an outdoor, shielded Ethernet cable to the *DATA* port.



3. Connect the other end of the cable from the *DATA* port to the Ethernet port labeled **POE** on the *airFiber PoE Adapter*.

WARNING: Use only the included airFiber PoE adapter, Model: **GP-H240-100G-4**. Failure to do so can damage the unit and void the product warranty.



4. Connect an Ethernet cable from your network to the Ethernet port labeled **LAN** on the *airFiber PoE Adapter*.

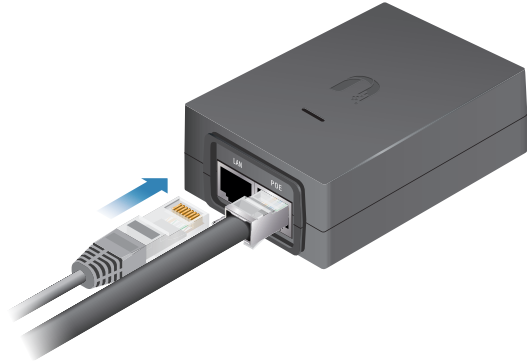

5. Connect the *Power Cord* to the power port on the *airFiber PoE Adapter*. Connect the other end of the *Power Cord* to a power source.

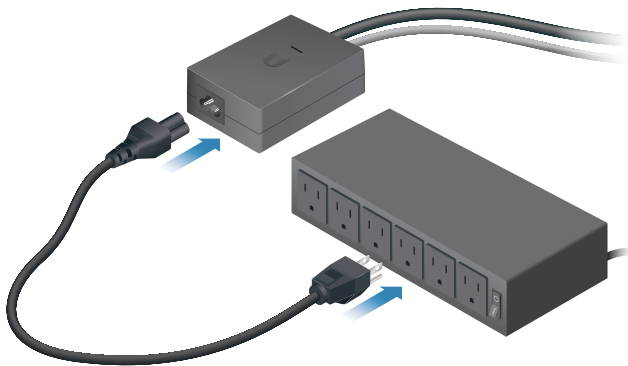

Mount the PoE Adapter (Optional)

1. Remove the *Mounting Bracket* from the adapter by sliding the bracket downward.



2. Place the *Mounting Bracket* at the desired location and mark the holes for the fasteners. Pre-drill the holes if necessary, then secure the bracket to wall using two fasteners (not included).

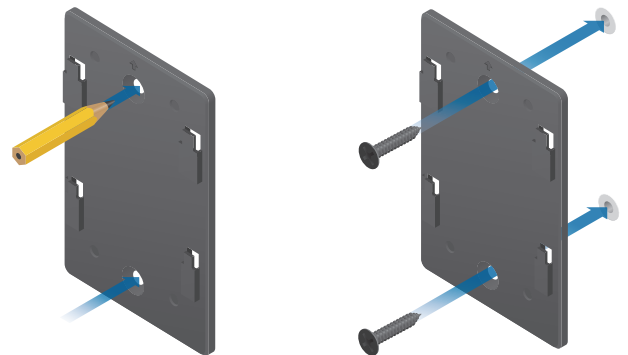

3. Attach the *airFiber PoE Adapter* to the bracket by aligning the four slots and tabs, and then slide the adapter downward.

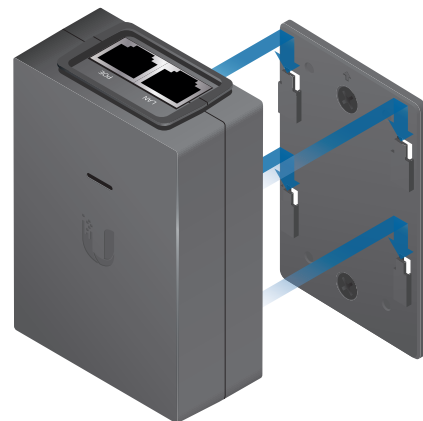

Surge Protection

For added protection, install two surge suppressors, such as the Ubiquiti Ethernet Surge Protector, model ETH-SP, at the end of each link. Install the first surge protector within one meter of the airFiber *DATA* port, and install the second surge protector at the ingress point of the location housing the wired network equipment.

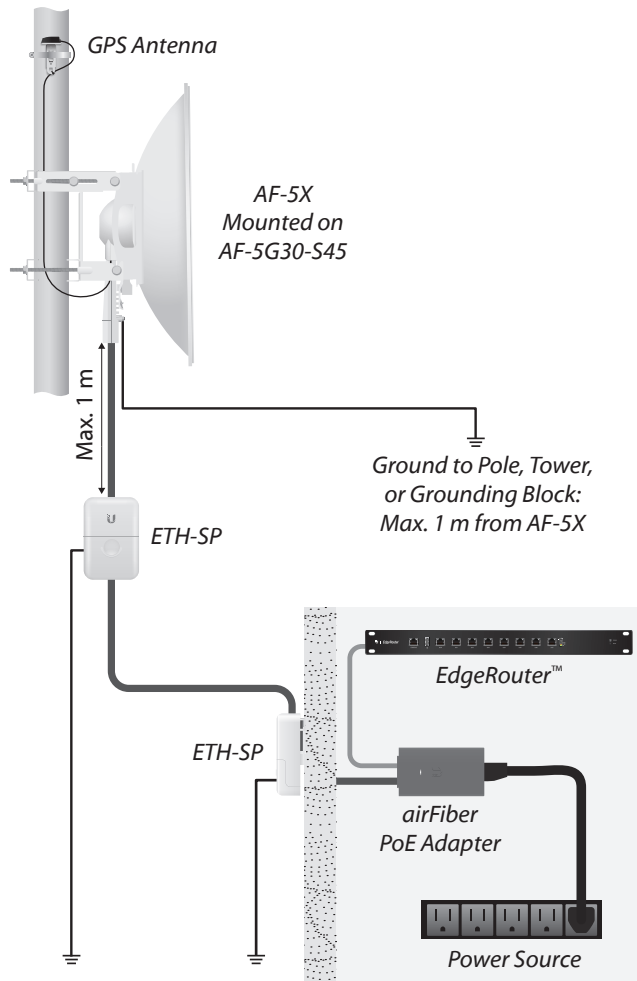

Alignment

Tips

- To accurately align the airFiber radios for best performance, you **MUST** align only one end of the link at a time.
- You may need to use additional hardware to compensate for issues such as the improper orientation of a mounting pole or significant elevation differences between airFiber radios.

Establishing a Link

Adjust the positions of the *Master* and the *Slave* to establish a link. The following guide features the airFiber antenna, AF-5G30-S45:

-  **Note:** The *Master* must be aimed first at the *Slave* because the *Slave* does not transmit any RF signal until it detects transmissions from the *Master*.

1. **Master** Visually aim the *Master* at the *Slave*. To adjust the *Master*'s position:
 - a. Loosen the four pole clamp nuts, and rotate the airFiber antenna on the pole to align the azimuth.

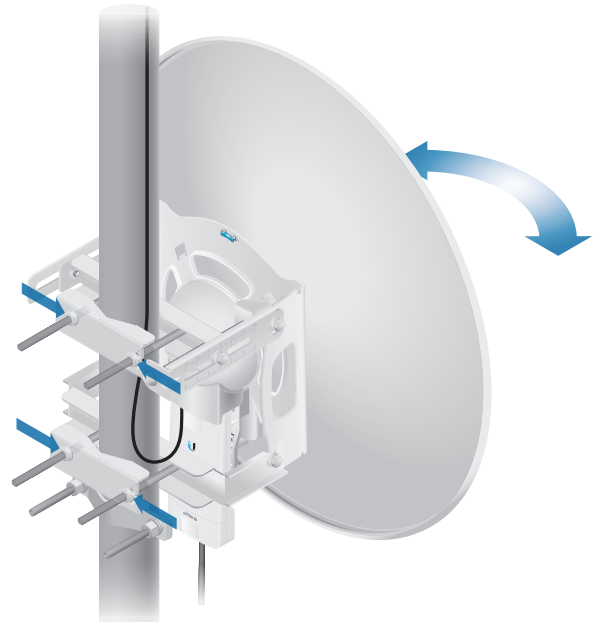

- b. Loosen the six elevation bolts, and use the hex nut on the elevation rod to adjust the elevation.

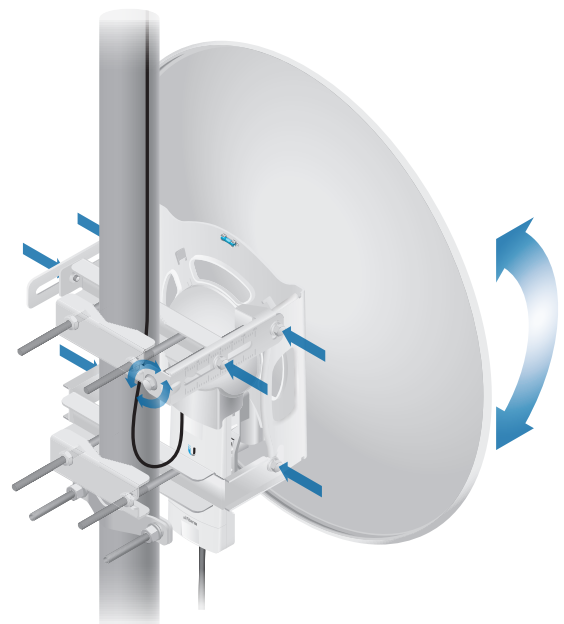

-  **Note:** Do NOT make simultaneous adjustments on the *Master* and *Slave*.

2. **Slave** Visually aim the *Slave* at the *Master*. To adjust the *Slave*'s position:
 - a. Loosen the four pole clamp nuts, and rotate the airFiber antenna on the pole to align the azimuth.
 - b. Loosen the six elevation bolts, and use the hex nut on the elevation rod to adjust the elevation.

3. Check to see if a link is established. Ensure that the *LINK* LED is solidly lit green and the *Signal* LEDs of the *Slave* are displaying signal levels.



4. **Slave** Aim the *Slave* at the *Master* to achieve the strongest signal level on the *Master*.

 **Note:** Refer to **“Signal LEDs” on page 2** for details on the signal values.

 **Note:** Maximum signal strength can best be achieved by iteratively sweeping through both azimuth and elevation.

5. **Master** Aim the *Master* at the *Slave* to achieve the strongest signal level on the *Slave*.
6. Repeat steps 4 and 5 until you achieve an optimal link, with all four *Signal* LEDs solidly lit. This ensures the best possible data rate between the airFiber radios.
7. Lock the alignment on both airFiber antennas by tightening all the nuts and bolts.
8. Observe the *Signal* LEDs of each airFiber radio to ensure that the values remain constant while tightening the nuts and bolts. If any LED value changes during the locking process, loosen the nuts and bolts, finalize the alignment of each airFiber antenna again, and retighten the nuts and bolts.

Refer to the following chapters of this User Guide for details on the airFiber Configuration Interface:

- **“Main Tab” on page 13**
- **“Wireless Tab” on page 16**
- **“Network Tab” on page 19**
- **“Advanced Tab” on page 21**
- **“Services Tab” on page 24**
- **“System Tab” on page 27**
- **“Tools” on page 30**

Installer Compliance Responsibility

Devices must be professionally installed and it is the professional installer’s responsibility to make sure the device is operated within local country regulatory requirements.

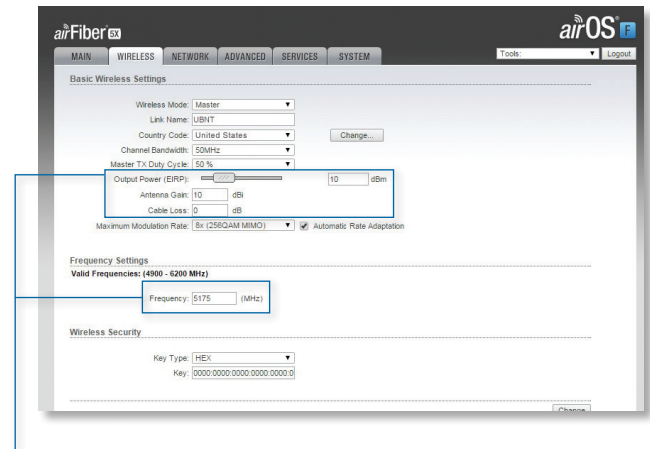

The *Output Power*, *Antenna Gain*, *Cable Loss*, and *Frequency* fields are provided to the professional installer to assist in meeting regulatory requirements.

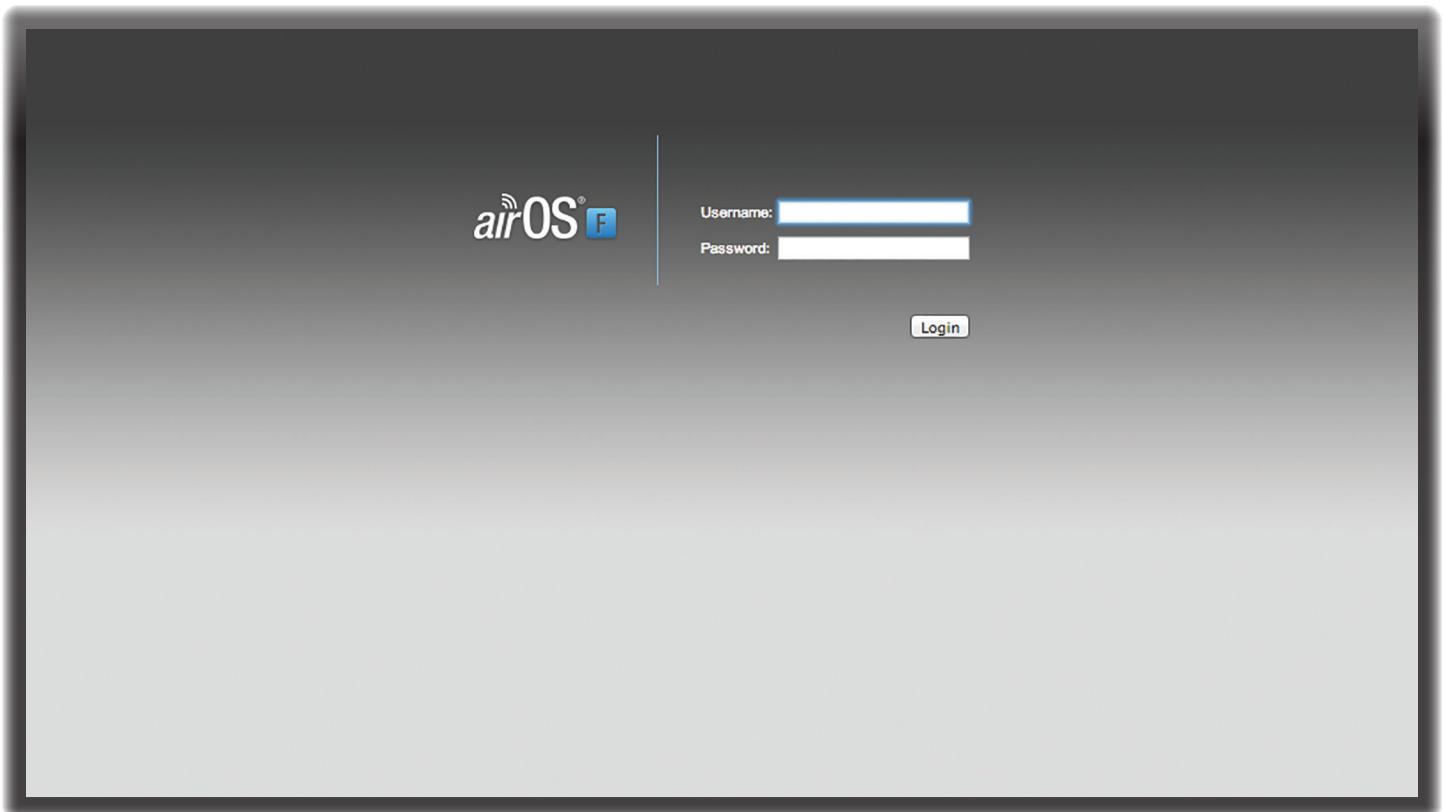

Chapter 3: Navigation

The airFiber Configuration Interface is an advanced operating system capable of powerful wireless and routing features, built upon a simple and intuitive user interface foundation.

The AF-5X uses the airFiber Configuration Interface for easy configuration and management via a web browser.

There are two ways to access the airFiber Configuration Interface:

- **Management Port** Enabled by default. Use a direct connection to the *Management* port for out-of-band management.
- **In-Band Management** Enabled by default. In-band management is available through the local *Data* port or the *Data* port at the other end of the link. You can disable it on the *Network* tab. (See **“Management Network Settings”** on page 19 for more details.)

Accessing the airFiber Configuration Interface

Connect to the airFiber Configuration Interface.

1. Make sure that your host machine is connected to the LAN that is connected to the *Management* port on the AF-5X.
2. Configure the Ethernet adapter on your host system with a static IP address on the 192.168.1.x subnet (for example, 192.168.1.100).

3. Launch your web browser. Type **http://192.168.1.20** in the address field and press **enter** (PC) or **return** (Mac).



4. Upon initial login, the *Terms of Use* appear on the login screen. Enter **ubnt** in the *Username* and *Password* fields, and select the appropriate choices from the *Country* and *Language* drop-down lists. Check the box next to *I agree to these terms of use*, and click **Login**.



Note: U.S. product versions are locked to the U.S. Country Code to ensure compliance with FCC regulations.

5. The airFiber Configuration Interface will appear, allowing you to customize your settings as needed.

Product Verification

The airFiber Configuration Interface will verify whether a product is genuine or counterfeit.

For a genuine airFiber AF-5X, the airFiber Configuration Interface will display a Genuine Product logo in the lower left corner of the screen.



For any product that is not an official Ubiquiti product, the airFiber Configuration Interface will display a counterfeit warning. Please contact Ubiquiti at support@ubnt.com regarding this product.



 **Note:** For product models introduced prior to 2012, the airFiber Configuration Interface will NOT display any logo in the lower left corner of the screen.

Interface Tabs

The airFiber Configuration Interface contains six main tabs, each of which provides a web-based management page to configure a specific aspect of the AF-5X. This User Guide covers each tab with a chapter. For details on a specific tab, refer to the appropriate chapter.

- **Main** The **“Main Tab” on page 13** displays device status, statistics, and network monitoring links.
- **Wireless** The **“Wireless Tab” on page 16** configures basic wireless settings, including the wireless mode, link name, frequency, output power, speed, and wireless security.
- **Network** The **“Network Tab” on page 19** configures the management network settings, Internet Protocol (IP) settings, management VLAN, and automatic IP aliasing.
- **Advanced** The **“Advanced Tab” on page 21** provides more precise wireless interface controls, including advanced wireless settings and advanced Ethernet settings.
- **Services** The **“Services Tab” on page 24** configures system management services: Ping Watchdog, Simple Network Management Protocol (SNMP), servers (web, SSH, telnet), Network Time Protocol (NTP) client, Dynamic Domain Name System (DDNS) client, system log, and device discovery.
- **System** The **“System Tab” on page 27** controls system maintenance routines, administrator account management, location management, device customization, firmware update, and configuration backup. You can also change the language of the web management interface.

Each page also contains network administration and monitoring tools:

- **“Align Antenna” on page 30**
- **“Discovery” on page 31**
- **“Ping” on page 31**
- **“Traceroute” on page 31**
- **“airView” on page 31**

Chapter 4: Main Tab

The *Main* tab displays a summary of the link status information, current values of the basic configuration settings, network settings and information, and traffic statistics.

Status

Device Name Displays the customizable name or identifier of the device. The Device Name (also known as host name) is displayed in registration screens and discovery tools.

Operating Mode Displays the mode of the AF-5X: *Slave*, *Master*, or *Reset*.

RF Link Status Displays the status of the AF-5X: *RF Off*, *Syncing*, *Beaconing*, *Registering*, *Enabling*, *Listening*, *Operational*, *DFS CAC*, or *RADAR Detected*.

Note: Most of the RF Link Statuses map to specific flash rates of the *Link Status* LED (See **"LEDs"** on [page 2](#) for more details.)

Status	Flash Rate of LED
RF Off	Off
Syncing	
DFS countries only:	Short Flash (1:3 on/off cycle)
• DFS CAC	
• RADAR Detected	
Beaconing	Normal Flash (1:1 on/off cycle)
Registering	Long Flash (3:1 on/off cycle)
Operational	On

When the AF-5X operates in a DFS country, it performs a Channel Availability Check (CAC) before operating. The rules vary by country and frequency, but in general:

- **FCC domains** If the AF-5X operates in the DFS band (5.4 GHz band), then the following rule applies:
 - If the *TX* and *RX Frequencies* are the same, then the AF-5X performs a 60-second check on the *Master* only.
 - If the *TX* and *RX Frequencies* are different, then the AF-5X performs a 60-second check on both the *Master* and *Slave*.
- **ETSI domains** For most frequencies, the AF-5X performs a 60-second check on the *Master* and *Slave*; however, if it operates in the 5600-5650 MHz range, then the AF-5X performs a 10-minute check.

While the AF-5X is performing this check, the *RF Link Status* displays *DFS CAC*, and the *RF Link Timeout* is displayed.

If radar is detected, the *RF Link Status* displays *RADAR Detected*, and the *RF Link Timeout* is displayed.

RF Link Timeout (Available only if the *RF Link Status* is *DFS CAC* or *RADAR Detected*.) During the *DFS CAC* or *RADAR Detected* state, the *RF Link Timeout* counts down the time remaining before the AF-5X can move to the next RF link state.

Link Name Displays the name of your link.

Security AES-128 is enabled at all times.

Version Displays the airFiber Configuration Interface software version.

Uptime This is the total time the device has been running since the latest reboot (when the device was powered up) or software upgrade. The time is displayed in days, hours, minutes, and seconds.

Link Uptime This is the total time the airFiber link has been continuously operational. The time is displayed in days, hours, minutes, and seconds.

Remote MAC Displays the Management Ethernet MAC address of the remote AF-5X.

Remote IP Displays the Management Ethernet IP address of the remote AF-5X.

Date Displays the current system date and time. The date and time are displayed in YEAR-MONTH-DAY HOURS:MINUTES:SECONDS format. The system date and time is retrieved from the Internet using NTP (Network Time Protocol). The NTP Client is enabled by default on the *Services* tab. The AF-5X doesn't have an internal clock, and the date and time may be inaccurate if the NTP Client is disabled or the device isn't connected to the Internet.

Frequency Displays the current frequency. The AF-5X uses the radio frequency specified to transmit and receive data.

Channel Width Size of the channel in MHz.

Duty Cycle Displays the duty cycle.

Regulatory Domain Displays the regulatory domain (*FCC/IC*, *ETSI*, or *Other*), as determined by country selection.

Chain 0/1 Signal Strength Displays the absolute power level (in dBm) of the received signal for each chain.

The software calculates the proper signal strength based on the measured distance and power levels, and then it scales the *Signal Strength* bar graphs so that when the link is aimed correctly, the bar graphs are full-scale. If the bar graphs are not full-scale, then they indicate that your link is not optimally aimed.

Remote Chain 0/1 Signal Strength Displays the absolute power level (in dBm) of the received signal for each chain of the remote AF-5X. The bar graphs will display as full-scale once the link is aimed correctly.

Local Modulation Rate Displays the modulation rate:

- 8x (256QAM MIMO)
- 6x (64QAM MIMO)
- 4x (16QAM MIMO)
- 2x (QPSK MIMO)
- 1x (½ Rate QPSK xRT™*)
- ¼x (¼ Rate QPSK xRT)

*xtreme Range Technology

If *Automatic Rate Adaptation* is enabled on the *Wireless* tab, then *Local Modulation Rate* displays the current speed in use and depends on the *Maximum Modulation Rate* specified on the *Wireless* tab and current link conditions.

Remote Modulation Rate Displays the modulation rate of the remote AF-5X:

- 8x (256QAM MIMO)
- 6x (64QAM MIMO)
- 4x (16QAM MIMO)
- 2x (QPSK MIMO)
- 1x (½ Rate QPSK xRT)
- ¼x (¼ Rate QPSK xRT)

TX Capacity Displays the potential TX throughput, how much the AF-5X can send, after accounting for the modulation and error rates.

RX Capacity Displays the potential RX throughput, how much the AF-5X can receive, after accounting for the modulation and error rates.

TX Power (EIRP) Displays the current average transmit output power (in dBm) of the AF-5X.



Note: If "(Limited)" is displayed, then the transmit output power has been limited to a value less than the selected value, to comply with regulatory region requirements. For a list of maximum output power values by country and region, refer to "**Frequency Ranges and Power Levels per Country/Region**" on [page 41](#).

Remote TX Power (EIRP) Displays the current average transmit output power (in dBm) of the remote AF-5X.

Distance Displays the distance between the airFiber radios.

GPS Signal Quality Displays Global Positioning System (GPS) signal quality as a percentage value on a scale of 0-100%.

Latitude/Longitude Based on GPS tracking, reports the device's current latitude and longitude. Clicking the link opens the reported latitude and longitude in a browser using Google Maps™ (<http://maps.google.com>).

Altitude Based on GPS tracking, reports the device's current altitude relative to sea level.

Synchronization airFiber uses GPS to synchronize the timing of its transmissions. By default, this option is disabled.

Ethernet

Ethernet	
MGMT MAC: 04:18:D6:51:00:28	DATA Pair 0 (Pins 1,2): open at 1 m (3 ft)
MGMT: 100Mbps-Full	DATA Pair 1 (Pins 3,6): open at 1 m (3 ft)
DATA: No Link	DATA Pair 2 (Pins 4,5): open at 1 m (3 ft)
DATA Cable Length: N/A	DATA Pair 3 (Pins 7,8): open at 0 m (0 ft)

MGMT MAC Displays the MAC address of the *Management* port.

MGMT Displays the speed and duplex of the *Management* port.

DATA Displays the speed and duplex of the *Data* port.

DATA Cable Length Displays the Ethernet cable length from radio to remote port. This is displayed only for cables longer than 20 m.

DATA Pair 0 (Pins 1,2) If the cable is functioning properly, displays the SNR of the twisted pair; if the cable has a fault, displays the fault ("open" or "short") and the distance at which the fault has occurred. If the remote port is administratively shut down, this field displays "normal".

DATA Pair 1 (Pins 3,6) If the cable is functioning properly, displays the SNR of the twisted pair; if the cable has a fault, displays the fault ("open" or "short") and the distance at which the fault has occurred. If the remote port is administratively shut down, this field displays "normal".

DATA Pair 2 (Pins 4,5) If the cable is functioning properly, displays the SNR of the twisted pair; if the cable has a fault, displays the fault ("open" or "short") and the distance at which the fault has occurred. If the remote port is administratively shut down, this field displays "normal".

DATA Pair 3 (Pins 7,8) If the cable is functioning properly, displays the SNR of the twisted pair; if the cable has a fault, displays the fault ("open" or "short") and the distance at which the fault has occurred. If the remote port is administratively shut down, this field displays "normal".

Monitor

There are two monitoring tools accessible via the links on the *Main* tab. The default is *Performance*, which is displayed when you first open the *Main* tab.

Performance

Throughput and *Capacity* charts display the current and potential data traffic.

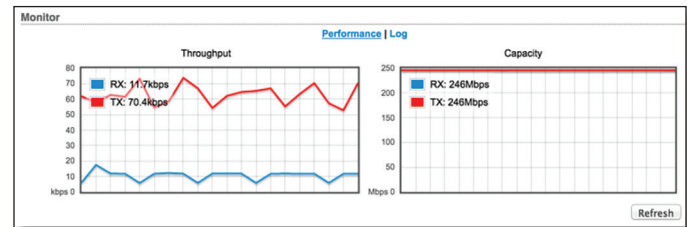

Throughput

Throughput displays the current data traffic on the *Data* port in both graphical and numerical form. The chart scale and throughput dimension (Bps, Kbps, Mbps) change dynamically depending on the mean throughput value. The statistics are updated automatically.

Capacity

Capacity displays the potential data traffic on the *Data* port in both graphical and numerical form. The chart scale and throughput dimension (Bps, Kbps, Mbps) change dynamically depending on the mean throughput value. The statistics are updated automatically.

Refresh If there is a delay in the automatic update, click **Refresh** to manually update the statistics.

Log

When logging is enabled (see "**System Log**" on page 26 to enable logging), this option lists all registered system events. By default, logging is not enabled.

```

System Log
Sep 27 15:55:22 system: Start
Sep 27 15:55:22 syslogd started: BusyBox v1.11.2
Sep 27 15:55:22 init: starting pid 1241, tty '/dev/null': '/bin/lighttpd -D -f /etc/lighttpd.conf'
Sep 27 15:55:22 init: starting pid 1242, tty '/dev/null': '/bin/tinysnmpd /etc/snmp.conf /lib/tinysnmp'
Sep 27 15:55:22 init: starting pid 1243, tty '/dev/null': '/bin/telnetd -F -p 23'
Sep 27 15:55:22 init: starting pid 1244, tty '/dev/null': '/bin/dropbear -F -d /etc/persistent/dropbear'
Sep 27 15:55:23 init: starting pid 1245, tty '/dev/null': '/bin/airfiberbox gpsd'
Sep 27 15:55:24 dropbear[1244]: Not backgrounding
  
```

Clear To delete all entries in the system log, click **Clear**.

Refresh To update the log content, click **Refresh**.

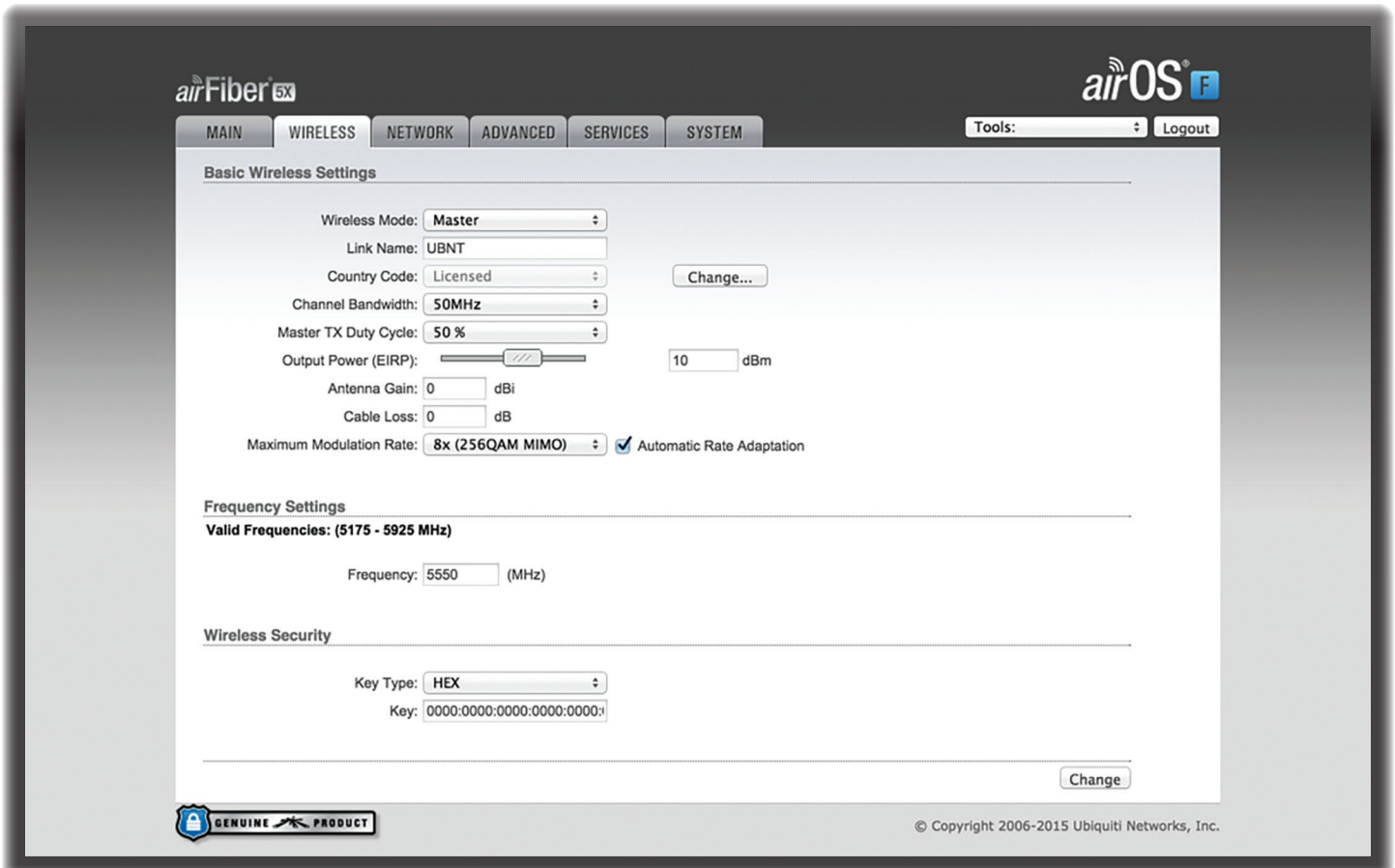

Chapter 5: Wireless Tab

The *Wireless* tab contains options to set up the wireless part of the link. This includes wireless mode, link name, frequencies, output power, speed, and wireless security.

Change To save or test your changes, click **Change**.

A new message appears. You have three options:

- **Apply** To immediately save your changes, click **Apply**.
- **Test** To try the changes without saving them, click **Test**. To keep the changes, click **Apply**. If you do not click *Apply* within 180 seconds (the countdown is displayed), the AF-5X times out and resumes its earlier configuration.
- **Discard** To cancel your changes, click **Discard**.

Write down the settings you configure on the *Wireless* tab. You will need to enter the same settings on the AF-5X at the other end of your PtP link. The exceptions are as follows:

- **Wireless Mode** Configure one AF-5X as the *Master* and the other as the *Slave*.

Basic Wireless Settings

In this section, configure the basic wireless settings, such as wireless mode, link name, country code, frequencies, output power, speed, and gain.

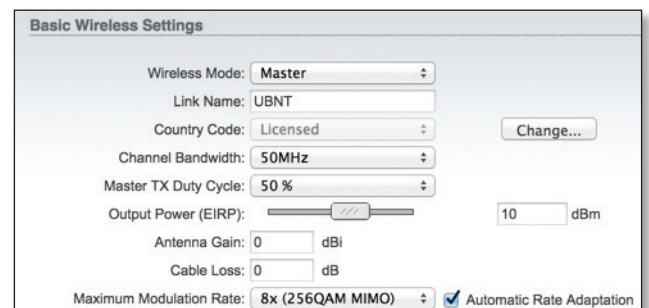

Wireless Mode By default, the Wireless Mode is *Slave*. You must configure one AF-5X as **Master** because each PtP link must have one *Master*.

Link Name Enter a name for your PtP link. This name must be the same on both Master and Slave radios in order for them to connect.

Country Code Each country has its own power level and frequency regulations. *To ensure the airFiber AF-5X operates under the necessary regulatory compliance rules, you must select the country where your device will be used.* The frequency settings and output power limits will be tuned according to the regulations of the selected country. For details, refer to this table, **“Frequency Ranges and Power Levels per Country/Region” on page 41.**

This radio is restricted to use with a license and to use only in certain EU countries or geographical areas of EU countries.

- **Change** To select a new country, click **Change**.



Note: U.S. product versions are locked to the U.S. Country Code to ensure compliance with FCC regulations.

Change Country

Country:

TERMS OF USE

This Ubiquiti Networks, Inc. radio device must be professionally installed. Properly installed shielded Ethernet cable and earth grounding must be used as conditions of product warranty. It is the installer's responsibility to follow local country regulations including operation within legal frequency channels, output power, and Dynamic Frequency Selection (DFS) requirements. The End User is responsible for keeping the unit working according to these rules. For further information, please visit www.ubnt.com.

I agree to these terms of use

- **Country** Select the new country.
- **I agree to these terms of use** Check this box; you must agree to the *Terms of Use* to use the product.
- **Accept** Saves your change.
- **Cancel** Discards your change.

Channel Bandwidth Select the appropriate channel size: **10, 20, 30, 40, or 50 MHz**.

Master TX Duty Cycle Use this to change the duty cycle of the RF link (the Master's TX percentage). Choose one of the following values: **25%, 33%, 50%, 67%, or 75%**.

Output Power (EIRP) Defines the maximum average transmit output power (in dBm) of the AF-5X. To specify the output power, use the slider or manually enter the output power value. The transmit power level maximum is limited according to country regulations.

Note: The *Antenna Gain* and *Cable Loss* should be configured before the *Output Power*. This is because the range of the *Output Power* field is affected by the *Antenna Gain* and *Cable Loss* values – changing the antenna gain or cable loss adjusts the maximum and minimum values you can select using the *Output Power* slider. Since the *Output Power* already includes the antenna gain and cable loss, it represents EIRP; therefore, the value of *Output Power* is actually the total power the radio is transmitting over the air. The current transmit power is displayed by the TX Power EIRP setting on the *Main* tab.



Note: The AF-5X may limit the output power to a value less than the value specified by this field, to comply with regulatory region requirements. For a list of maximum output power values by country and region, refer to **“Frequency Ranges and Power Levels per Country/Region” on page 41**.



Antenna Gain Enter the gain in dBi of the antenna that is used in your installation. An improper value could cause DFS false detections when operating on DFS frequencies.

Cable Loss Enter the cable loss in dB of the cable that is used in your installation. An improper value could cause DFS false detections when operating on DFS frequencies.

Maximum Modulation Rate or Modulation Rate Higher modulations support greater throughput but generally require stronger RF signals and a higher Signal-to-Noise Ratio (SNR). By default, *Automatic Rate Adaptation* is enabled, and *Maximum Modulation Rate* is displayed. This allows the AF-5X to automatically adjust the modulation rate to changing RF signal conditions. Under certain conditions, you may prefer to lock the *Maximum Modulation Rate* to a lower setting to improve link performance.

When *Automatic Rate Adaptation* is disabled, *Modulation Rate* is displayed. Lock the *Modulation Rate* to the setting of your choice.

Select one of the available modulation rates:

- **8x (256QAM MIMO)**
- **6x (64QAM MIMO)**
- **4x (16QAM MIMO)**
- **2x (QPSK MIMO)**
- **1x (½ Rate QPSK xRT)**
- **¼x (¼ Rate QPSK xRT)**

Frequency Settings

The *Valid Frequencies* for your *Country Code* selection are displayed. Ensure that you use frequencies that comply with the local country regulations.

Frequency Enter a valid frequency. The current state is displayed.



Note: The Master and Slave should have the same *Frequency* setting.

DFS Frequencies

If you have Dynamic Frequency Selection (DFS) frequencies, then you have three sets of *Frequency* options.

Frequency Settings

Valid Frequencies: (5175 - 5225 MHz) (5275 - 5325 MHz) (5495 - 5575 MHz) (5675 - 5700 MHz) (5752 - 5823 MHz)

Frequency 1: (MHz) Current State: Operating

Frequency 2: (MHz)

Frequency 3: (MHz)

Frequency 1-3 Enter a valid frequency (the same frequency will be used for both transmit and receive). The *Current State* is displayed.

Wireless Security

airFiber uses 128-bit, AES (Advanced Encryption Standard) encryption at all times.

The screenshot shows a configuration window titled "Wireless Security". It has two main fields: "Key Type" and "Key". The "Key Type" is a dropdown menu currently showing "HEX". The "Key" field is a text input containing the hexadecimal value "0000:0000:0000:0000:0000:0000:0000:0000".

Key Type Specifies the character format.

- **HEX** By default, this option uses hexadecimal characters. 0-9, A-F, or a-f are valid characters.
- **ASCII** ASCII uses the standard English alphabet and numeric characters (0-9, A-Z, or a-z).

Key Select the format of the MAC address.

- **HEX** Enter 16 bytes (eight, 16-bit HEX values). You can omit zeroes and use colons, similar to the IPv6 format. The default is:

0000:0000:0000:0000:0000:0000:0000:0000



Note: The airFiber Configuration Interface supports IPv6 formats excluding dotted quad and "::" (double-colon) notation.

- **ASCII** Enter a combination of alphanumeric characters. Using 128-bit, SHA1 (Secure Hash Algorithm 1), the airFiber AF-5X hashes the ASCII key to create a 128-bit key for AES.

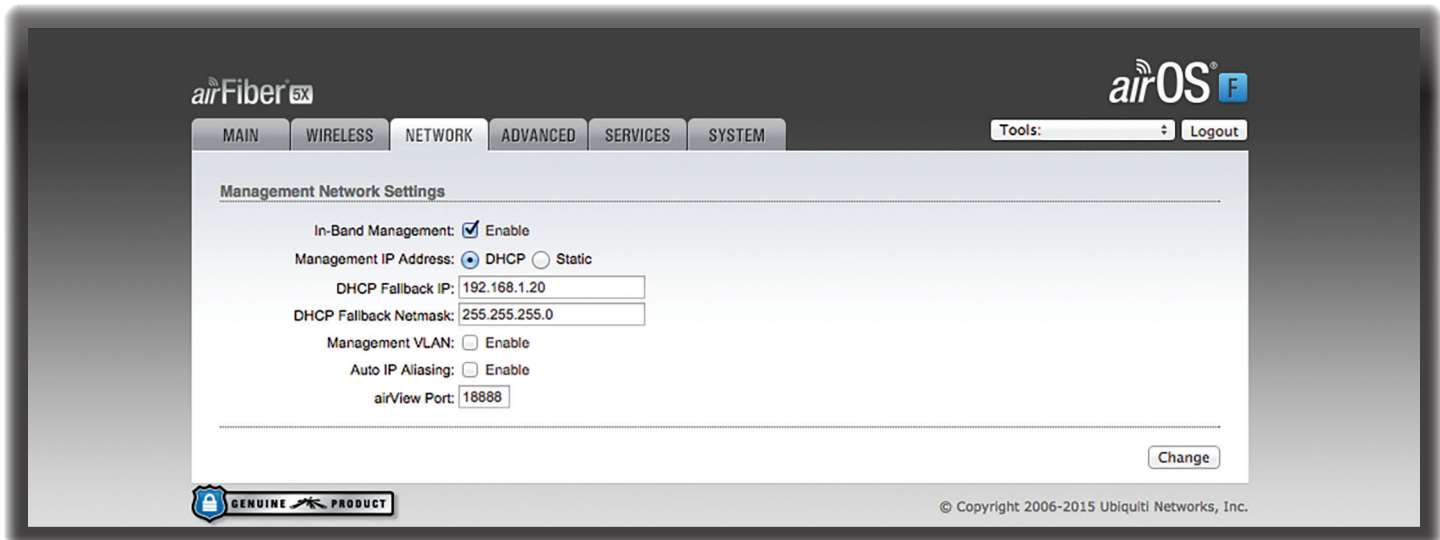

Chapter 6: Network Tab

The *Network* tab allows you to configure settings for the management network.

There are two ways to access the airFiber Configuration Interface:

- **Management Port** Enabled by default. Use a direct connection to the *Management* port for out-of-band management.
- **In-Band Management** Enabled by default. In-band management is available through the local *Data* port or the *Data* port at the other end of the link.

The *Management* port and in-band management share the default IP address of *192.168.1.20*.

Change To save or test your changes, click **Change**.

A new message appears. You have three options:

- **Apply** To immediately save your changes, click **Apply**.
- **Test** To try the changes without saving them, click **Test**. To keep the changes, click **Apply**. If you do not click *Apply* within 180 seconds (the countdown is displayed), the AF-5X times out and resumes its earlier configuration.
- **Discard** To cancel your changes, click **Discard**.

Management Network Settings

In-Band Management Enabled by default. In-band management is available through the local *Data* port or the *Data* port at the other end of the link.



Note: If *In-Band Management* is enabled, ensure that each airFiber radio of a link has a unique *IP Address*. If the airFiber radios use the same *IP Address*, then you may lose access via the *Data* ports.

Management IP Address The AF-5X can use a static IP address or obtain an IP address from its DHCP server.

- **DHCP** Keep the default, *DHCP*, to use DHCP reservation on your router to assign a unique *IP Address*. The local

DHCP server assigns a reserved IP address, gateway IP address, and DNS address to the AF-5X.



Note: If you select the *DHCP* option, ensure that you use DHCP reservation because if you do not know the IP address, then the only way to manage the AF-5X is to reset the AF-5X to its factory default settings. (Press and hold the **Reset** button for more than five seconds.) Its default *Management IP Address* is reset to *192.168.1.20*.

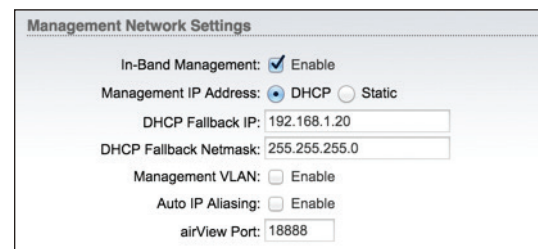

- **DHCP Fallback IP** Specify the IP address the AF-5X should use if a DHCP server is not found.
- **DHCP Fallback Netmask** Specify the netmask the AF-5X should use if a DHCP server is not found.
- **Static** Assign static IP settings to the AF-5X.



Note: IP settings should be consistent with the address space of the AF-5X's network segment.

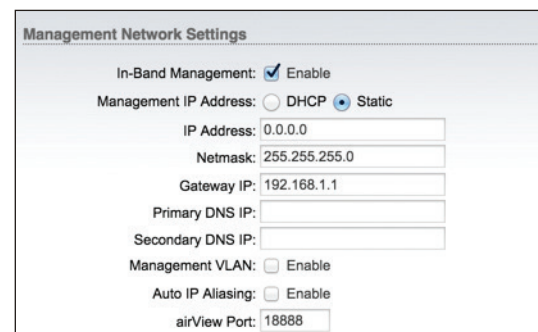

- **IP Address** Specify the IP address of the AF-5X. This IP will be used for device management purposes.
- **Netmask** When the netmask is expanded into its binary form, it provides a mapping to define which portions of the IP address range are used for the network devices and which portions are used for host devices. The netmask defines the address space of the AF-5X's network segment. The 255.255.255.0 (or "/24") netmask is commonly used on many Class C IP networks.
- **Gateway IP** Typically, this is the IP address of the host router, which provides the point of connection to the Internet. This can be a DSL modem, cable modem, or WISP gateway router. The AF-5X directs data packets to the gateway if the destination host is not within the local network.
- **Primary DNS IP** Specify the IP address of the primary DNS (Domain Name System) server.
- **Secondary DNS IP** Specify the IP address of the secondary DNS server. This entry is optional and used only if the primary DNS server is not responding.

Management VLAN If enabled, automatically creates a management Virtual Local Area Network (VLAN).

- **VLAN ID** Enter a unique VLAN ID from 2 to 4094.

Auto IP Aliasing If enabled, automatically generates an IP address for the corresponding WLAN/LAN interface. The generated IP address is a unique Class B IP address from the 169.254.X.Y range (netmask 255.255.0.0), which is intended for use within the same network segment only. The Auto IP always starts with 169.254.X.Y, with X and Y as the last two octets from the MAC address of the AF-5X. For example, if the MAC address is 00:15:6D:A3:04:FB, then the generated unique Auto IP will be 169.254.4.251. (The hexadecimal value, *FB*, converts to the decimal value, *251*.)

The Auto IP Aliasing setting can be useful because you can still access and manage devices even if you lose, misconfigure, or forget their IP addresses. Because an Auto IP address is based on the last two octets of the MAC address, you can determine the IP address of a device if you know its MAC address.

airView Port The port number associated with the airView spectrum analyzer tool. The default value is 18888. For detailed information on the airView tool, refer to **"airView" on page 31**.

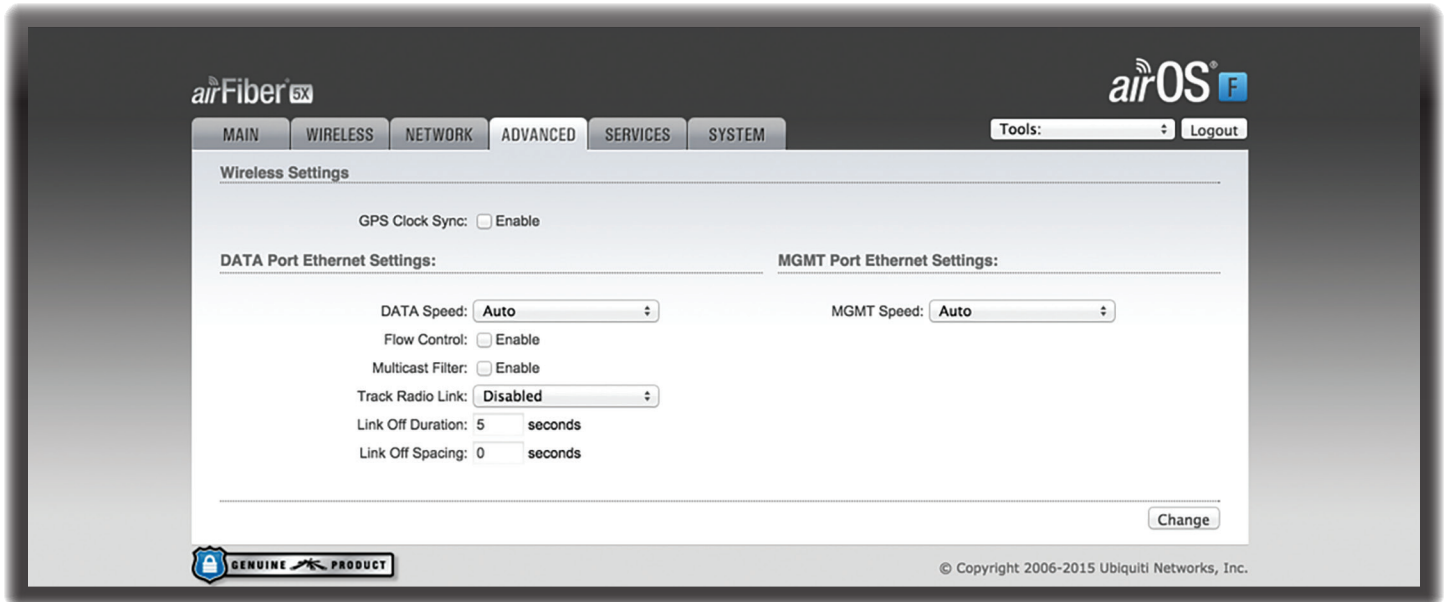

Chapter 7: Advanced Tab

The *Advanced* tab handles advanced wireless and Ethernet settings. These settings should not be changed unless you know the effects the changes will have on the AF-5X.

Change To save or test your changes, click **Change**.

A new message appears. You have three options:

- **Apply** To immediately save your changes, click **Apply**.
- **Test** To try the changes without saving them, click **Test**. To keep the changes, click **Apply**. If you do not click **Apply** within 180 seconds (the countdown is displayed), the airFiber AF-5X times out and resumes its earlier configuration.
- **Discard** To cancel your changes, click **Discard**.

Wireless Settings

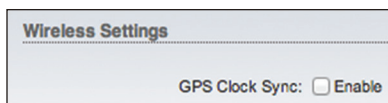

GPS Clock Sync The airFiber uses GPS to synchronize the timing of its transmissions. By default, this option is disabled.

DATA Port Ethernet Settings

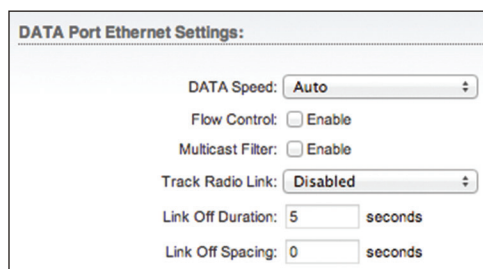

DATA Speed This is the speed of the *Data* port. By default, the option is **Auto**. The airFiber AF-5X automatically negotiates transmission parameters, such as speed and duplex, with its counterpart. In this process, the networked devices first share their capabilities and then choose the fastest transmission mode they both support.

To manually specify the maximum transmission link speed and duplex mode, select one of the following options: **100 Mbps-Full**, **100 Mbps-Half**, **10 Mbps-Full**, or **10 Mbps-Half**.

Full-duplex mode allows communication in both directions simultaneously. Half-duplex mode allows communication in one direction at a time, alternating between transmission and reception.

Flow Control If enabled, the AF-5X generates and responds to Ethernet layer PAUSE frames. The AF-5X regulates inbound traffic from the customer's network to avoid buffer overflows within the AF-5X. Flow control has the effect of controlling the inter-packet spacing of packets headed into the airFiber Data interface.

Multicast Filter If enabled, the filter blocks multicast traffic from overloading the CPU when in-band management is enabled. This allows the AF-5X to be managed in-band when the customer's network is carrying large volumes of multicast traffic, such as IPTV. The filter does not block multicast traffic going over the radio; it simply blocks it from reaching the airFiber's management interface CPU.

Track Radio Link If this option is enabled, the AF-5X disconnects the Data port's Ethernet link when the RF link is lost (The Management port is never disabled by this option). The *Track Radio Link* option is useful because it quickly indicates a "link lost" condition to the customer's routing equipment (such as a direct connection to OSPF-enabled routers).

- **Disabled** The *Track Radio Link* option is disabled by default. The Data port's Ethernet link will always remain up regardless of the RF link state.
- **Use Timeout Duration** This option is designed for use by operators who are using in-band management. Two timers control the Data port's Ethernet link.

RF Link	Ethernet Link	Notes
Goes down for the first time	The Ethernet link goes down and remains down for the number of seconds specified by the <i>Link Off Duration</i> timer. The Ethernet link will then come back up so that the AF-5X can be managed even when the RF link is down.	Even if the RF link goes back up before the <i>Link Off Duration</i> timer elapses, the Ethernet link remains down. The Ethernet link's downtime is long enough to signal to the customer's routing equipment that the path is lost.
Goes down for the second time	The Ethernet link remains up as long as time remains on the <i>Link Off Spacing</i> timer. When the <i>Link Off Spacing</i> timer elapses, then the Ethernet link goes down again for the number of seconds specified by the <i>Link Off Duration</i> timer. (This happens only if the RF link is still down.)	The Ethernet link's uptime is long enough so the operator has enough time to access the AF-5X, make configuration changes, and save those changes. Sufficient Ethernet link uptime is vital when a RF link is constantly up and down.

If the *Use Timeout Duration* option is enabled, the *Track Radio Link* option and the following timers are enabled:

- **Link Off Duration** The *Link Off Duration* timer controls the length of time the Data port's Ethernet link will be down if the RF link goes down. Enter the number of seconds that the Ethernet link should be offline. For example, if this is set to 10 seconds, then when the RF link goes down, the Ethernet link will go down and remain down for 10 seconds (regardless of the RF link state), and then it will go back up.
- **Link Off Spacing** The *Link Off Spacing* timer controls the length of time the AF-5X will wait before allowing the Data port's Ethernet link to go down for a second time if the RF link goes down again. Enter the minimum interval (in seconds) between offline events of the Ethernet link, regardless of the RF link status. The value for *Link Off Spacing* should be larger than the value for *Link Off Duration*, and it should be enough time for the operator to access the AF-5X, make any configuration changes, and apply those changes.



Note: If the *Link Off Spacing* timer is set to 0 seconds, then the Ethernet link will only use the *Link Off Duration* timer. If the *Link Off Duration* timer is set to 10 seconds and the RF link goes down, then the Ethernet link will go down for 10 seconds and then go back up regardless of the RF link state. If the RF link is still down, then the Ethernet link will not go down again until the RF link goes back up and then down again.

Here are a couple of examples involving the use of the *Use Timeout Duration* option.

• Example #1

- **Link Off Duration** 5 seconds
- **Link Off Spacing** 60 seconds

The Data port's Ethernet link will be initially disconnected when the RF link first goes down. That event will start a 60-second timer. The Ethernet link will remain offline for 5 seconds (regardless of the RF link status) and then come back online. The Ethernet link will remain online (regardless of the RF link state) until the 60-second timer expires.

• Example #2

- **Link Off Duration** 20 seconds
- **Link Off Spacing** 120 seconds

The Data port's Ethernet link will be initially disconnected when the RF link first goes down. That event will start a 120-second timer. The RF link goes back up after 10 seconds; however, that does not affect the Ethernet link. The Ethernet link will remain offline for 20 seconds and then come back online. The RF link goes down again after 60 seconds; however, that does not affect the Ethernet link. The Ethernet link will then remain online until the 120-second timer expires.

- **Enabled** This option is designed for use by operators who are not using in-band management. The *Track Radio Link* option is enabled without timers, so the Data port's Ethernet link follows the RF link state exactly. If the RF link goes down, then the Ethernet link goes down and remains down until the RF link goes back up.

MGMT Port Ethernet Settings



MGMT Speed This is the speed of the *Management* port. By default, the option is **Auto**. The airFiber AF-5X automatically negotiates transmission parameters, such as speed and duplex, with its counterpart. In this process, the networked devices first share their capabilities and then choose the fastest transmission mode they both support.

To manually specify the maximum transmission link speed and duplex mode, select one of the following options: **100 Mbps-Full**, **100 Mbps-Half**, **10 Mbps-Full**, or **10 Mbps-Half**. If you are running extra long Ethernet cables, a link speed of *10* Mbps could help to achieve better stability.

Full-duplex mode allows communication in both directions simultaneously. Half-duplex mode allows communication in one direction at a time, alternating between transmission and reception.

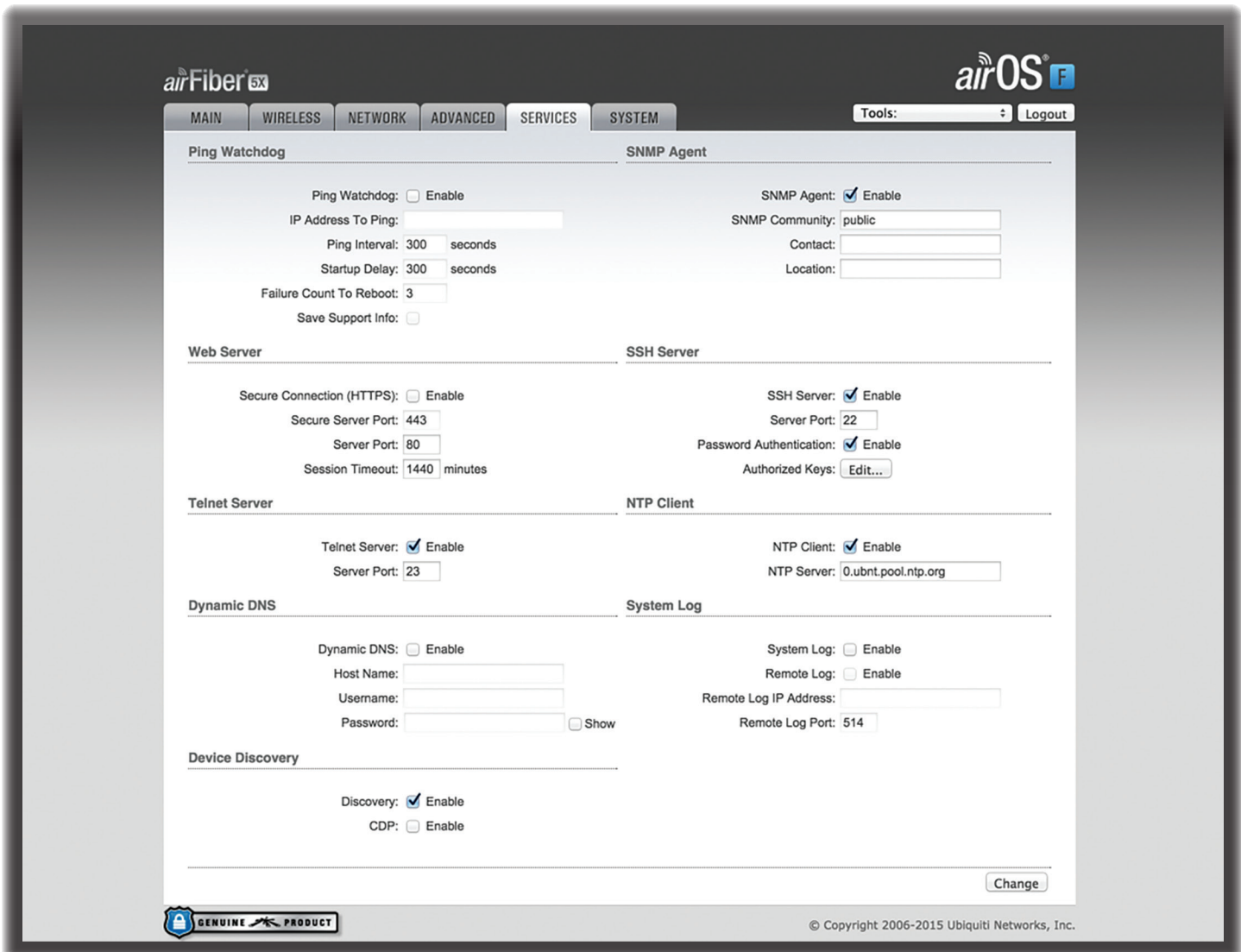

Chapter 8: Services Tab

The *Services* tab configures system management services: *Ping Watchdog*, *SNMP Agent*, *Web Server*, *SSH Server*, *Telnet Server*, *NTP Client*, *Dynamic DNS*, *System Log*, and *Device Discovery*.

Change To save or test your changes, click **Change**.

A new message appears. You have three options:

- **Apply** To immediately save your changes, click **Apply**.
- **Test** To try the changes without saving them, click **Test**. To keep the changes, click **Apply**. If you do not click *Apply* within 180 seconds (the countdown is displayed), the AF-5X times out and resumes its earlier configuration.
- **Discard** To cancel your changes, click **Discard**.

Ping Watchdog

Ping Watchdog sets the AF-5X to continuously ping a user-defined IP address (it can be the Internet gateway, for example). If it is unable to ping under the user-defined

constraints, then the AF-5X will automatically reboot. This option creates a kind of “fail-proof” mechanism.

Ping Watchdog is dedicated to continuous monitoring of the specific connection to the remote host using the *Ping* tool. The *Ping* tool works by sending ICMP echo request packets to the target host and listening for ICMP echo response replies. If the defined number of replies is not received, the tool reboots the AF-5X.

Ping Watchdog Enables use of *Ping Watchdog*.

- **IP Address To Ping** Specify the IP address of the target host to be monitored by *Ping Watchdog*.

- **Ping Interval** Specify the time interval (in seconds) between the ICMP echo requests that are sent by *Ping Watchdog*. The default value is 300 seconds.
- **Startup Delay** Specify the initial time delay (in seconds) until the first ICMP echo requests are sent by *Ping Watchdog*. The default value is 300 seconds.
The Startup Delay value should be at least 60 seconds as the network interface and wireless connection initialization takes a considerable amount of time if the AF-5X is rebooted.
- **Failure Count to Reboot** Specify the number of ICMP echo response replies. If the specified number of ICMP echo response packets is not received continuously, *Ping Watchdog* will reboot the AF-5X. The default value is 3.
- **Save Support Info** This generates a support information file.

SNMP Agent

Simple Network Monitor Protocol (SNMP) is an application layer protocol that facilitates the exchange of management information between network devices. Network administrators use SNMP to monitor network-attached devices for issues that warrant attention.

The AF-5X contains an *SNMP Agent*, which does the following:

- Provides an interface for device monitoring using SNMP
- Communicates with SNMP management applications for network provisioning
- Allows network administrators to monitor network performance and troubleshoot network problems

For the purpose of equipment identification, configure the *SNMP Agent* with contact and location information:

SNMP Agent Enables the *SNMP Agent*.

- **SNMP Community** Specify the SNMP community string. It is required to authenticate access to Management Information Base (MIB) objects and functions as an embedded password. The AF-5X also supports a read-only community string; authorized management stations have read access to all the objects in the MIB except the community strings, but do not have write access. The AF-5X supports SNMP v1. The default SNMP Community is *public*.
- **Contact** Specify the contact who should be notified in case of emergency.
- **Location** Specify the physical location of the AF-5X.

Web Server

The following *Web Server* parameters can be set:

Secure Connection (HTTPS) If enabled, the *Web Server* uses secure HTTPS mode.

- **Secure Server Port** If secure HTTPS mode is used, specify the TCP/IP port of the *Web Server*.

Server Port If HTTP mode is used, specify the TCP/IP port of the *Web Server*.

Session Timeout Specifies the maximum timeout before the session expires. Once a session expires, you must log in again using the username and password.

SSH Server

The following *SSH Server* parameters can be set:

SSH Server This option enables SSH access to the AF-5X.

- **Server Port** Specify the TCP/IP port of the *SSH Server*.
- **Password Authentication** If enabled, you must authenticate using administrator credentials to grant SSH access to the AF-5X; otherwise, an authorized key is required.
- **Authorized Keys** Click **Edit** to import a public key file for SSH access to the AF-5X instead of using an admin password.

- **Choose File** Click **Choose File** to locate the new key file. Select the file and click **Open**.
- **Import** Imports the file for SSH access.
- **Enabled** Enables the specific key. All the added keys are saved in the system configuration file; however, only the enabled keys are active on the AF-5X.
- **Type** Displays the type of key.

- **Key** Displays the key.
- **Comment** You can enter a brief description of the key.
- **Action** You have the following options:
 - **Add** Adds a public key file.
 - **Edit** Make changes to a public key file. Click **Save** to save your changes.
 - **Del** Deletes a public key file.
- **Save** Saves your changes.
- **Close** Discards your changes.

Telnet Server

The following *Telnet Server* parameters can be set:

Telnet Server This option activates Telnet access to the AF-5X.

- **Server Port** Specify the TCP/IP port of the *Telnet Server*.

NTP Client

Network Time Protocol (NTP) is a protocol for synchronizing the clocks of computer systems over packet-switched, variable-latency data networks. You can use it to set the system time on the AF-5X. If the *Log* option is enabled, then the system time is reported next to every log entry that registers a system event.

NTP Client Enables the AF-5X to obtain the system time from a time server on the Internet.

- **NTP Server** Specify the IP address or domain name of the NTP server.

Dynamic DNS

Domain Name System (DNS) translates domain names to IP addresses; Each DNS server on the Internet holds these mappings in its respective DNS database. Dynamic Domain Name System (DDNS) is a network service that notifies the DNS server in real time of any changes in the AF-5X's IP settings. Even if the AF-5X's IP address changes, you can still access the AF-5X through its domain name.

Dynamic DNS If enabled, the AF-5X allows communications with the DDNS server.

- **Host Name** Enter the host name of the DDNS server.
- **Username** Enter the user name of the DDNS account.
- **Password** Enter the password of the DDNS account.
- **Show** Check the box to display the password characters.

System Log

System Log This option enables the registration routine of system log (syslog) messages. By default it is disabled.

- **Remote Log** Enables the syslog remote sending function. System log messages are sent to a remote server, which is specified in the *Remote Log IP Address* and *Remote Log Port* fields.
 - **Remote Log IP Address** The host IP address that receives syslog messages. Properly configure the remote host to receive syslog protocol messages.
 - **Remote Log Port** The TCP/IP port that receives syslog messages. *514* is the default port for the commonly used system message logging utilities.

Every logged message contains at least a system time and host name. Usually a specific service name that generates the system event is also specified within the message. Messages from different services have different contexts and different levels of detail. Usually error, warning, or informational system service messages are reported; however, more detailed debug level messages can also be reported. The more detailed the system messages reported, the greater the volume of log messages generated.

Device Discovery

Discovery Enables device discovery, so the AF-5X can be discovered by other Ubiquiti devices through the *Discovery* tool.

CDP Enables Cisco Discovery Protocol (CDP) communications, so the AF-5X can send out CDP packets to share its information.

Chapter 9: System Tab

The *System* tab contains administrative options. This page enables the administrator to reboot the AF-5X, reset it to factory defaults, upload new firmware, back up or update the configuration, and configure the administrator account.

Change To save or test your changes, click **Change**.

A new message appears. You have three options:

- **Apply** To immediately save your changes, click **Apply**.
- **Test** To try the changes without saving them, click **Test**. To keep the changes, click **Apply**. If you do not click *Apply* within 180 seconds (the countdown is displayed), the AF-5X times out and resumes its earlier configuration.
- **Discard** To cancel your changes, click **Discard**.

Firmware Update

The controls in this section manage firmware maintenance.

Firmware Version Displays the current firmware version.

Build Number Displays the build number of the firmware version.

Check for Updates By default, the firmware automatically checks for updates. To manually check for an update, click **Check Now**.

Upload Firmware Click this button to update the AF-5X with new firmware.

The AF-5X firmware update is compatible with all configuration settings. The system configuration is preserved while the AF-5X is updated with a new firmware version. However, we recommend that you back up your current system configuration before updating the firmware.

This is a three-step procedure:

1. Click **Choose File** to locate the new firmware file. Select the file and click **Open**.
2. Click **Upload** to upload the new firmware to the AF-5X.
3. The Uploaded Firmware Version is displayed. Click **Update** to confirm.

If the firmware update is in process, you can close the firmware update window, but this does not cancel the firmware update. Please be patient, as the firmware update routine can take three to seven minutes. You cannot access the AF-5X until the firmware update routine is completed.



WARNING: Do not power off, do not reboot, and do not disconnect the AF-5X from the power supply during the firmware update process as these actions will damage the AF-5X!

Device

The Device Name (host name) is the system-wide device identifier. The SNMP agent reports it to authorized management stations. The Device Name will be used in popular router operating systems, registration screens, and discovery tools.

Device Name Specifies the host name.

Interface Language Allows you to select the language displayed in the web management interface. *English* is the default language.

Date Settings

Time Zone Specifies the time zone in relation to Greenwich Mean Time (GMT).

Startup Date When enabled, you are able to change the AF-5X's startup date.

- **Startup Date** Specifies the AF-5X's startup date. Click the **Calendar** icon or manually enter the date in the following format: 2-digit month/2-digit day/4-digit year. For example, for January 5, 2014, enter **01/05/2014** in the field.

System Accounts

You can change the administrator password to protect your device from unauthorized changes. We recommend that you change the default administrator password when initially configuring the device.

Administrator Username Specifies the name of the administrator.

Key icon Click this icon to change the administrator password.

- **Current Password** Enter the current password for the administrator account. It is required to change the *Password* or *Administrator Username*.
- **New Password** Enter the new password for the administrator account.
- **Verify New Password** Re-enter the new password for the administrator account.



Note: The password length is 8 characters maximum; passwords exceeding 8 characters will be truncated.

Read-Only Account Check the box to enable the read-only account, which can only view the *Main* tab. Configure the username and password to protect your device from unauthorized changes.

- **Read-Only Account Name** Specifies the name of the system user.
- **Key icon** Click this icon to change the read-only password.
 - **New Password** Enter the new password for the read-only account.
 - **Show** Check the box to display the read-only password characters.

Miscellaneous

Reset Button To allow use of the AF-5X's physical reset button, check the box. To prevent an accidental reset to default settings, uncheck the box.



Note: You can reset the AF-5X to default settings via the airFiber Configuration Interface. Go to the *System* tab > *Reset to Defaults*.

Location

After the on-board GPS determines the location of the AF-5X, its latitude and longitude are displayed. If the GPS does not have a fix on its location, then “Searching for Satellites” will be displayed.

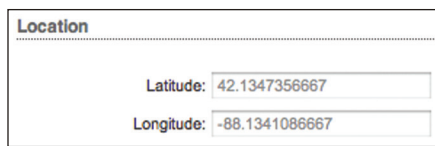

The screenshot shows a window titled "Location" with two input fields. The "Latitude" field contains the value "42.1347356667" and the "Longitude" field contains the value "-88.1341086667".

Latitude The latitude of the AF-5X’s location is displayed.

Longitude The longitude of the AF-5X’s location is displayed.

Device Maintenance

The controls in this section manage the AF-5X maintenance routines: reboot and support information reports.

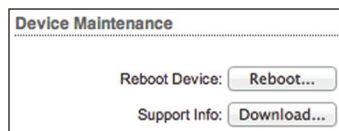

The screenshot shows a window titled "Device Maintenance" with two buttons. The "Reboot Device:" button is labeled "Reboot..." and the "Support Info:" button is labeled "Download...".

Reboot Device Initiates a full reboot cycle of the AF-5X. Reboot is the same as the hardware reboot, which is similar to the power-off and power-on cycle. The system configuration stays the same after the reboot cycle completes. Any changes that have not been applied are lost.

Support Info This generates a support information file that the Ubiquiti support engineers can use when providing customer support. This file only needs to be generated at their request.

Configuration Management

The controls in this section manage the AF-5X configuration routines and the option to reset the AF-5X to factory default settings.

The AF-5X configuration is stored in a plain text file (.cfg file). You can back up, restore, or update the system configuration file:

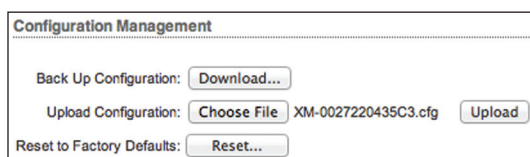

The screenshot shows a window titled "Configuration Management" with three buttons. The "Back Up Configuration:" button is labeled "Download...". The "Upload Configuration:" section includes a "Choose File" button, the filename "XM-0027220435C3.cfg", and an "Upload" button. The "Reset to Factory Defaults:" button is labeled "Reset...".

Back Up Configuration Click **Download** to download the current system configuration file.

Upload Configuration Click **Choose File** to locate the new configuration file. Select the file and click **Open**. We recommend that you back up your current system configuration before uploading the new configuration.

Upload Click this button to upload the new configuration file to the AF-5X. Click **Apply** to confirm.

After the AF-5X reboots, the settings of the new configuration are displayed in the *Wireless, Network, Advanced, Services, and System* tabs of the airFiber Configuration Interface.

Reset to Factory Defaults Resets the AF-5X to the factory default settings. This option will reboot the AF-5X, and all factory default settings will be restored. We recommend that you back up your current system configuration before resetting the AF-5X to its defaults.



Chapter 10: Tools

Each tab of the airFiber Configuration Interface contains network administration and monitoring tools. Click the **Tools** drop-down list at the top right corner of the page.

Align Antenna

Use the *Align Antenna* tool to point and optimize the antenna in the direction of maximum link signal. The *Antenna Alignment* window is designed to refresh every 250 milliseconds.

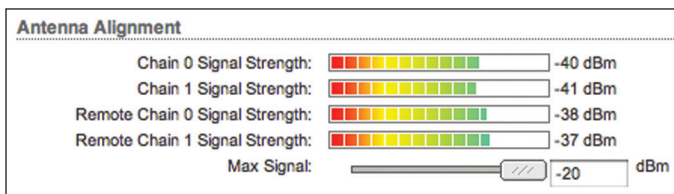

Chain 0/1 Signal Strength Displays the absolute power level (in dBm) of the received signal for each chain.



Note: If “Overload” is displayed to indicate an overload condition, identify and eliminate any sources of strong in-band interference.

Remote Chain 0/1 Signal Strength Displays the absolute power level (in dBm) of the received signal for each chain of the remote airFiber radio.

Max Signal Displays the maximum signal strength (in dBm). To adjust the range of the *Max Signal* meter, use the slider or manually enter the new value. If you reduce the range, the color change will be more sensitive to signal fluctuations, indicating the offset of the maximum indicator value and the scale itself.

- **Launch airView** Click **Launch airView** to download the Java Network Launch Protocol (jnlp) file and complete the launch of airView.

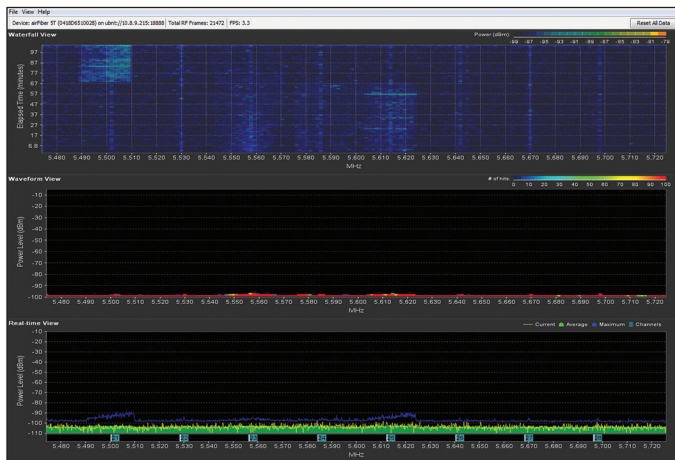
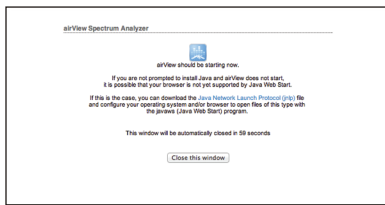

Main View

Device Displays the device name, MAC (Media Access Control) address, and IP address of the device running airView.

Total RF Frames Displays the total number of Radio Frequency (RF) frames gathered since the start of the airView session or since the *Reset All Data* button was last clicked.

FPS Displays the total number of frames per second (FPS) gathered since the start of the airView session or since the *Reset All Data* button was last clicked. The wider the interval amplitude, the fewer the FPS will be gathered.

Reset All Data Click to reset all gathered data. Use this option to analyze the spectrum for another location or address.

File Menu

Click **Exit** to end the airView session.

View Menu

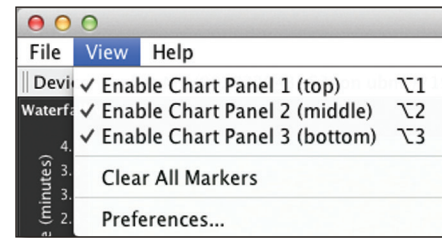

Enable Chart Panel 1 (top) Displays the Waterfall or Channel Usage chart in Chart Panel 1, depending on which option you have selected in *Preferences*. This time-based graph shows the aggregate energy collected or channel usage for each frequency since the start of the airView session.

Enable Chart Panel 2 (middle) Displays the Waveform chart in Chart Panel 2. This time-based graph shows the RF signature of the noise environment since the start of the airView session. The energy color designates its amplitude. Cooler colors represent lower energy levels (with blue representing the lowest levels) in that frequency bin, and warmer colors (yellow, orange, or red) represent higher energy levels in that frequency bin.

Enable Chart Panel 3 (bottom) Displays the Real-time chart (traditional spectrum analyzer) in Chart Panel 3. Energy (in dBm) is shown in real time as a function of frequency.



Note: Energy is the power ratio in decibels (dB) of the measured power referenced to one milliwatt (mW).

Clear All Markers Resets all previously assigned markers. Markers are assigned by clicking a point, which corresponds with a frequency on the Real-time chart.

Preferences Changes airView settings, such as enabling or disabling charts and traces, or specifying the frequency interval.

Preferences

Select **View > Preferences** to display the *Preferences - airView Spectrum Analyzer* window.

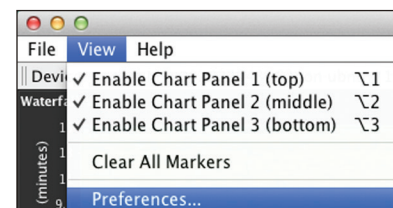

Charts

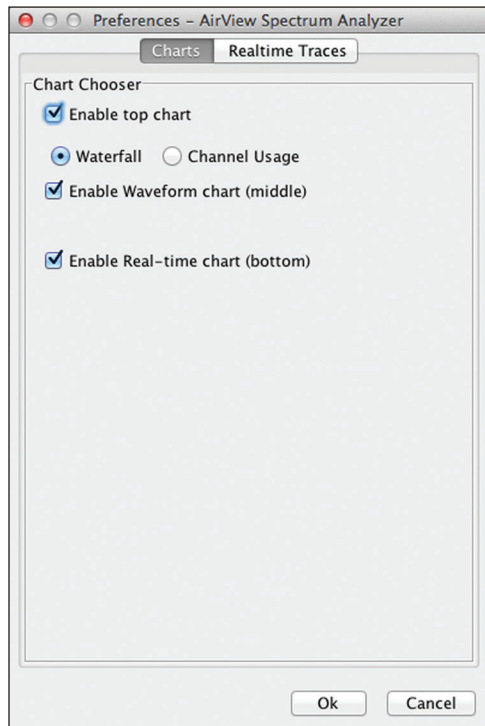

Enable top chart Check the box to enable the top chart. Select the desired chart to display in the top chart panel on the main view. There are two options:

- **Waterfall** This time-based graph shows the aggregate energy collected for each frequency since the start of the airView session. The energy color designates its amplitude. Cooler colors represent lower energy levels (with blue representing the lowest levels) in that frequency bin, and warmer colors (yellow, orange, or red) represent higher energy levels in that frequency bin.

The Waterfall View's legend (top-right corner) provides a numerical guide associating the various colors to power levels (in dBm). The low end of that legend (left) is always adjusted to the calculated noise floor, and the high end (right) is set to the highest detected power level since the start of the airView session.

- **Channel Usage** For each channel, a bar displays a percentage showing the relative "crowdedness" of that specific channel. To calculate this percentage, the airView Spectrum Analyzer analyzes both the popularity and strength of RF energy in that channel since the start of an airView session.



Note: AF-5X channels are not related to Wi-Fi channels which are determined by IEEE standards. AF-5X channels are numbered consecutively starting with 0 and are 28 MHz in width.

Enable Waveform chart (middle) Check the box to enable the middle chart. This time-based graph shows the RF signature of the noise environment since the start of the airView session. The energy color designates its amplitude. Cooler colors represent lower energy levels (with blue representing the lowest levels) in that frequency bin, and warmer colors (yellow, orange, or red) represent higher energy levels in that frequency bin.

The spectral view over time will display the steady-state RF energy signature of a given environment.

Enable Real-time chart (bottom) Check the box to enable the bottom chart. This graph displays a traditional spectrum analyzer in which energy (in dBm) is shown in real time as a function of frequency. There are three traces in this view:

- **Current** (Yellow) Shows the real-time energy seen by the device as a function of frequency.
- **Average** (Green) Shows the running average energy across frequency.
- **Maximum** (Blue) Shows updates and maximum power levels across frequency.

Real-Time Traces

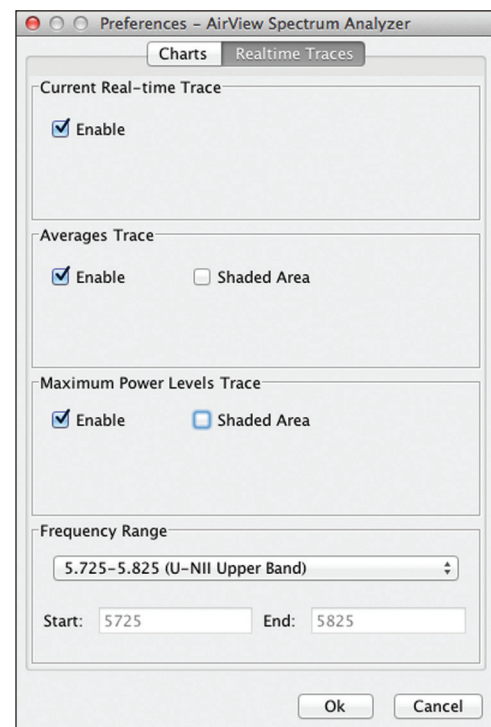

The following settings apply only to the *Real-time* chart:

Current Real-time Trace Check the *Enable* box to enable the real-time trace. When enabled, the yellow outline on the *Real-time* chart represents the real-time power level of each frequency. The refresh speed depends on the FPS.

Averages Trace Check the *Enable* box to enable the averages trace. When enabled, the averages trace is represented by the green area on the *Real-time* chart, which displays the average received power level data since the start of the airView session. To enable a shaded green area, check the *Shaded Area* box. To display only a green outline without the shaded area, uncheck the *Shaded Area* box.

Maximum Power Levels Trace Check the *Enable* box to enable the maximum power trace. When enabled, the maximum power trace is represented by the blue area on the *Real-time* chart, which displays the maximum received power level data since the start of the airView session. To enable a shaded blue area, check the *Shaded Area* box. To display only a blue outline without the shaded area, uncheck the *Shaded Area* box.

Frequency Range Select the amplitude of the frequency interval to be scanned from the *Frequency Range* drop-down list. Available frequencies are device-dependent. There are pre-defined ranges for the most popular bands. You can enter a custom range; select **Custom Range** from the *Frequency Range* drop-down list and enter the desired values in the *Start* and *End* fields.

Appendix A: Specifications

airFiber AF-5X	
Dimensions	224 x 82 x 48 mm (8.82 x 3.23 x 1.89")
Weight	0.35 kg (0.77 lb)
RF Connectors	(2) RP-SMA Weatherproof (CH0, CH1) (1) SMA Weatherproof (GPS)
GPS Antenna	External, Magnetic Base
Max. Conducted TX Power	26 dBm (Depends on Regulatory Region)
Power Supply	24V, 1A PoE Gigabit Adapter (Included)
Power Method	Passive Power over Ethernet
Mounting	Rocket Mount Compatible GPS Pole Mount (Included)
Certifications	FCC Part 15.407 CE EN 302502 v1.2.1, EN 301 893 v1.7.1
Operating Temperature	-40 to 55° C (-40 to 131° F)
Networking Interface	
Data Port	(1) 10/100/1000 Ethernet Port
Management Port	(1) 10/100 Ethernet Port
System	
Maximum Throughput	500 Mbps
Encryption	128-bit AES
OS	airOS F
Wireless Modes	Master/Slave
Radio	
Operating Frequency	5150-5925 MHz (Depends on Regulatory Region)
Frequency Accuracy	± 2.5 ppm without GPS Synchronization ± 0.2 ppm with GPS Synchronization
Channel Bandwidth	10 MHz, 20 MHz, 30 MHz, 40 MHz, 50 MHz Selectable

Appendix B: Safety Notices

1. Read, follow, and keep these instructions.
2. Heed all warnings.
3. Only use attachments/accessories specified by the manufacturer.

 **WARNING:** Do not use this product in location that can be submerged by water.

 **WARNING:** Avoid using this product during an electrical storm. There may be a remote risk of electric shock from lightning.

Electrical Safety Information

1. Compliance is required with respect to voltage, frequency, and current requirements indicated on the manufacturer's label. Connection to a different power source than those specified may result in improper operation, damage to the equipment or pose a fire hazard if the limitations are not followed.
2. There are no operator serviceable parts inside this equipment. Service should be provided only by a qualified service technician.
3. This equipment is provided with a detachable power cord which has an integral safety ground wire intended for connection to a grounded safety outlet.
 - a. Do not substitute the power cord with one that is not the provided approved type. Never use an adapter plug to connect to a 2-wire outlet as this will defeat the continuity of the grounding wire.
 - b. The equipment requires the use of the ground wire as a part of the safety certification, modification or misuse can provide a shock hazard that can result in serious injury or death.
 - c. Contact a qualified electrician or the manufacturer if there are questions about the installation prior to connecting the equipment.
 - d. Protective earthing is provided by Listed AC adapter. Building installation shall provide appropriate short-circuit backup protection.
 - e. Protective bonding must be installed in accordance with local national wiring rules and regulations.

Appendix C: Warranty

Limited Warranty

UBIQUITI NETWORKS, Inc (“UBIQUITI NETWORKS”) warrants that the product(s) furnished hereunder (the “Product(s)”) shall be free from defects in material and workmanship for a period of one (1) year from the date of shipment by UBIQUITI NETWORKS under normal use and operation. UBIQUITI NETWORKS’ sole and exclusive obligation and liability under the foregoing warranty shall be for UBIQUITI NETWORKS, at its discretion, to repair or replace any Product that fails to conform to the above warranty during the above warranty period. The expense of removal and reinstallation of any Product is not included in this warranty. The warranty period of any repaired or replaced Product shall not extend beyond its original term.

Warranty Conditions

The above warranty does not apply if the Product:

- (I) has been modified and/or altered, or an addition made thereto, except by Ubiquiti Networks, or Ubiquiti Networks’ authorized representatives, or as approved by Ubiquiti Networks in writing;
- (II) has been painted, rebranded or physically modified in any way;
- (III) has been damaged due to errors or defects in cabling;
- (IV) has been subjected to misuse, abuse, negligence, abnormal physical, electromagnetic or electrical stress, including lightning strikes, or accident;
- (V) has been damaged or impaired as a result of using third party firmware;
- (VI) has no original Ubiquiti MAC label, or is missing any other original Ubiquiti label(s); or
- (VII) has not been received by Ubiquiti within 30 days of issuance of the RMA.

In addition, the above warranty shall apply only if: the product has been properly installed and used at all times in accordance, and in all material respects, with the applicable Product documentation; all Ethernet cabling runs use CAT5 (or above), and for outdoor installations, shielded Ethernet cabling is used, and for indoor installations, indoor cabling requirements are followed.

 **WARNING: Failure to properly ground your airFiber units will void your warranty.** (Please follow the instructions on **“Install a Ground Wire”** on page 5 for installation of the ground wires.)

Returns

No Products will be accepted for replacement or repair without obtaining a Return Materials Authorization (RMA) number from UBIQUITI NETWORKS during the warranty period, and the Products being received at UBIQUITI NETWORKS’ facility freight prepaid in accordance with the RMA process of UBIQUITI NETWORKS. Products returned without an RMA number will not be processed and will be returned freight collect or subject to disposal. Information on the RMA process and obtaining an RMA number can be found at: www.ubnt.com/support/warranty.

Disclaimer

EXCEPT FOR ANY EXPRESS WARRANTIES PROVIDED HEREIN, UBIQUITI NETWORKS, ITS AFFILIATES, AND ITS AND THEIR THIRD PARTY DATA, SERVICE, SOFTWARE AND HARDWARE PROVIDERS HEREBY DISCLAIM AND MAKE NO OTHER REPRESENTATION OR WARRANTY OF ANY KIND, EXPRESS, IMPLIED OR STATUTORY, INCLUDING, BUT NOT LIMITED TO, REPRESENTATIONS, GUARANTEES, OR WARRANTIES OF MERCHANTABILITY, ACCURACY, QUALITY OF SERVICE OR RESULTS, AVAILABILITY, SATISFACTORY QUALITY, LACK OF VIRUSES, QUIET ENJOYMENT, FITNESS FOR A PARTICULAR PURPOSE AND NON-INFRINGEMENT AND ANY WARRANTIES ARISING FROM ANY COURSE OF DEALING, USAGE OR TRADE PRACTICE IN CONNECTION WITH SUCH PRODUCTS AND SERVICES. BUYER ACKNOWLEDGES THAT NEITHER UBIQUITI NETWORKS NOR ITS THIRD PARTY PROVIDERS CONTROL BUYER’S EQUIPMENT OR THE TRANSFER OF DATA OVER COMMUNICATIONS FACILITIES, INCLUDING THE INTERNET, AND THAT THE PRODUCTS AND SERVICES MAY BE SUBJECT TO LIMITATIONS, INTERRUPTIONS, DELAYS, CANCELLATIONS AND OTHER PROBLEMS INHERENT IN THE USE OF COMMUNICATIONS FACILITIES. UBIQUITI NETWORKS, ITS AFFILIATES AND ITS AND THEIR THIRD PARTY PROVIDERS ARE NOT RESPONSIBLE FOR ANY INTERRUPTIONS, DELAYS, CANCELLATIONS, DELIVERY FAILURES, DATA LOSS, CONTENT CORRUPTION, PACKET LOSS, OR OTHER DAMAGE RESULTING FROM ANY OF THE FOREGOING. In addition, UBIQUITI NETWORKS does not warrant that the operation of the Products will be error-free or that operation will be uninterrupted. In no event shall UBIQUITI NETWORKS be responsible for damages or claims of any nature or description relating to system performance, including coverage, buyer’s selection of products (including the Products) for buyer’s application and/or failure of products (including the Products) to meet government or regulatory requirements.

Limitation of Liability

EXCEPT TO THE EXTENT PROHIBITED BY LOCAL LAW, IN NO EVENT WILL UBIQUITI OR ITS SUBSIDIARIES, AFFILIATES OR SUPPLIERS BE LIABLE FOR DIRECT, SPECIAL, INCIDENTAL, CONSEQUENTIAL OR OTHER DAMAGES (INCLUDING LOST PROFIT, LOST DATA, OR DOWNTIME COSTS), ARISING OUT OF THE USE, INABILITY TO USE, OR THE RESULTS OF USE OF THE PRODUCT, WHETHER BASED IN WARRANTY, CONTRACT, TORT OR OTHER LEGAL THEORY, AND WHETHER OR NOT ADVISED OF THE POSSIBILITY OF SUCH DAMAGES.

Note

Some countries, states and provinces do not allow exclusions of implied warranties or conditions, so the above exclusion may not apply to you. You may have other rights that vary from country to country, state to state, or province to province. Some countries, states and provinces do not allow the exclusion or limitation of liability for incidental or consequential damages, so the above limitation may not apply to you. EXCEPT TO THE EXTENT ALLOWED BY LOCAL LAW, THESE WARRANTY TERMS DO NOT EXCLUDE, RESTRICT OR MODIFY, AND ARE IN ADDITION TO, THE MANDATORY STATUTORY RIGHTS APPLICABLE TO THE LICENSE OF ANY SOFTWARE (EMBEDDED IN THE PRODUCT) TO YOU. The United Nations Convention on Contracts for the International Sale of Goods shall not apply to any transactions regarding the sale of the Products.

Appendix D: Compliance Information

Installer Compliance Responsibility

Devices must be professionally installed and it is the professional installer's responsibility to make sure the device is operated within local country regulatory requirements.

FCC

Changes or modifications not expressly approved by the party responsible for compliance could void the user's authority to operate the equipment.

This device complies with Part 15 of the FCC Rules. Operation is subject to the following two conditions.

1. This device may not cause harmful interference, and
2. This device must accept any interference received, including interference that may cause undesired operation.

This equipment has been tested and found to comply with the limits for a Class B digital device, pursuant to part 15 of the FCC Rules. These limits are designed to provide reasonable protection against harmful interference in a residential installation. This equipment generates, uses and can radiate radio frequency energy and, if not installed and used in accordance with the instructions, may cause harmful interference to radio communications. However, there is no guarantee that interference will not occur in a particular installation. If this equipment does cause harmful interference to radio or television reception, which can be determined by turning the equipment off and on, the user is encouraged to try to correct the interference by one or more of the following measures:

- Reorient or relocate the receiving antenna.
- Increase the separation between the equipment and receiver.
- Connect the equipment into an outlet on a circuit different from that to which the receiver is connected.
- Consult the dealer or an experienced radio/TV technician for help.

Operations of this equipment in a residential area is likely to cause harmful interference in which case the user will be required to correct the interference at his own expense.

This radio transmitter (FCC: SWX-AF5X) has been approved by FCC to operate with the antenna types listed below with the maximum permissible gain and required antenna impedance for each antenna type indicated. Antenna types not included in this list, having a gain greater than the maximum gain indicated for that type, are strictly prohibited for use with this device.

- Dish antenna, gain: 34 dBi

DFS Regulatory Regions

Operation in DFS regulatory regions requires an antenna with minimum gain of 23 dBi.

Industry Canada

CAN ICES-3(B)/NMB-3(B)

To reduce potential radio interference to other users, the antenna type and its gain should be so chosen that the equivalent isotropically radiated power (e.i.r.p.) is not more than that permitted for successful communication.

This device complies with Industry Canada licence-exempt RSS standard(s). Operation is subject to the following two conditions:

1. This device may not cause interference, and
2. This device must accept any interference, including interference that may cause undesired operation of the device.

Users should also be advised that high-power radars are allocated as primary users (i.e. priority users) of the bands 5250-5350 MHz and 5650-5850 MHz and that these radars could cause interference and/or damage to LE-LAN devices. This radio transmitter (IC: 6545A-AF5X) has been approved by Industry Canada to operate with the antenna types listed below with the maximum permissible gain and required antenna impedance for each antenna type indicated. Antenna types not included in this list, having a gain greater than the maximum gain indicated for that type, are strictly prohibited for use with this device.

- Dish antenna, gain: 34 dBi

DFS Regulatory Regions

Operation in DFS regulatory regions requires an antenna with minimum gain of 23 dBi.

CAN ICES-3(B)/NMB-3(B)

Pour réduire le risque d'interférence aux autres utilisateurs, le type d'antenne et son gain doivent être choisis de façon que la puissance isotrope rayonnée équivalente (PIRE) ne dépasse pas ce qui est nécessaire pour une communication réussie.

Cet appareil est conforme à la norme RSS Industrie Canada exempts de licence norme(s). Son fonctionnement est soumis aux deux conditions suivantes:

1. Cet appareil ne peut pas provoquer d'interférences et
2. Cet appareil doit accepter toute interférence, y compris les interférences qui peuvent causer un mauvais fonctionnement du dispositif.

Les utilisateurs devraient également noter que radars haute puissants sont alloués comme principaux utilisateurs (c'est-à-dire les utilisateurs de priorité) des bandes 5250-5350 MHz et 5650 à 5850 MHz et que ces radars pourraient causer des interférences ou dommages aux dispositifs LAN. Cet émetteur radio (IC: 6545A-AF5X) a été approuvée par Industrie Canada pour l'exploitation avec l'antenne types énumérés ci-dessous avec le gain maximal admissible et requis l'impédance de l'antenne pour chaque type d'antenne indiqué. Types d'antenne non inclus dans cette liste, ayant un gain supérieur au gain maximal indiqué pour ce type, sont strictement interdits pour une utilisation avec cet appareil. Immédiatement suite à la remarque, le fabricant doit fournir une liste de tous les types d'antenne

approuvé pour une utilisation avec l'émetteur, ce qui indique le gain maximal d'antenne permis (en dBi) et requis d'impédance pour chacun.

- Antenne parabolique, gain: 34 dBi

Régions Réglementaires DFS

Opération dans les régions réglementaires DFS nécessite une antenne avec un gain minimum de 23 dBi.

RF Exposure Warning

The antennas used for this transmitter must be installed to provide a separation distance of at least 126 cm from all persons and must not be located or operating in conjunction with any other antenna or transmitter.

Les antennes utilisées pour ce transmetteur doivent être installé en considérant une distance de séparation de toute personnes d'au moins 126 cm et ne doivent pas être localisé ou utilisé en conflit avec tout autre antenne ou transmetteur.

Australia and New Zealand



Warning: This is a Class B product. In a domestic environment this product may cause radio interference in which case the user may be required to take adequate measures.

CE Marking

CE marking on this product represents the product is in compliance with all directives that are applicable to it.

Alert sign! follows CE marking

Alert sign must be indicated if a restriction on use applied to the product and it must follow the CE marking.



Frequency Ranges and Power Levels per Country/Region

The product can be operated in the countries and regions listed in the following table, within the stated frequency ranges and output power (EIRP) limits.

Each country has its own power level and frequency regulations. To ensure the product operates under the necessary regulatory compliance rules, the country where the device will be used must be selected during installation. The frequency settings and output power (EIRP) limits will be tuned according to the regulations of the selected country/region:

Country/Region	5.1 GHz		5.2 GHz		5.4 GHz		5.8 GHz	
	Frequency Range (Band Edges in MHz)	Max. EIRP (dBm)	Frequency Range (Band Edges in MHz)	Max. EIRP (dBm)	Frequency Range (Band Edges in MHz)	Max. EIRP (dBm)	Frequency Range (Band Edges in MHz)	Max. EIRP (dBm)
Argentina	5150-5250	49			5470-5725	30	5725-5850	36
Australia					5470-5600, 5650-5725	30	5725-5855	36
Bahrain							5735-5835	20
Barbados							5725-5850	36
Belize							5735-5835	30
Bolivia							5735-5835	30
Brazil					5470-5725	30	5725-5850	30
Brunei Darussalam							5735-5835	20
Canada			5250-5350	30	5470-5600, 5650-5725	30	5725-5850	54
Chile			5250-5350	30			5735-5835	20
China							5735-5835	30
Colombia			5250-5350	30			5735-5835	30
Costa Rica							5735-5835	30
Denmark					5470-5725	30	5725-5795, 5815-5850	36
Dominican Republic							5735-5835	30
Ecuador	5150-5250	49	5250-5350	30			5735-5835	30
El Salvador							5735-5835	30
Finland					5470-5725	30	5725-5795, 5815-5850	36
Germany					5470-5725	30	5755-5875	36
Greece					5470-5725	30	5725-5795	36
Grenada					5470-5725	30	5725-5850	36
Guatemala							5735-5835	30
Honduras					5470-5725	30	5725-5850	36
Hong Kong			5250-5350	30	5470-5725	30	5725-5850	36
Iceland					5470-5725	30	5725-5875	36
India							5825-5875	36
Iraq							5735-5835	36
Ireland					5470-5725	30	5725-5875	33
Jamaica					5470-5725	30	5725-5850	36
Kenya			5250-5350	30			5735-5835	30
Korea Republic					5490-5710	30	5735-5815	30

Country/Region	5.1 GHz		5.2 GHz		5.4 GHz		5.8 GHz	
	Frequency Range (Band Edges in MHz)	Max. EIRP (dBm)	Frequency Range (Band Edges in MHz)	Max. EIRP (dBm)	Frequency Range (Band Edges in MHz)	Max. EIRP (dBm)	Frequency Range (Band Edges in MHz)	Max. EIRP (dBm)
Lebanon							5735-5835	30
Liechtenstein					5470-5725	30	5725-5795, 5815-5875	36
Macau							5725-5850	36
Malaysia	5150-5250	49	5250-5350	30			5735-5835	30
Mexico							5735-5835	30
Morocco							5735-5835	20
Nepal							5735-5835	30
New Zealand					5470-5725	30	5725-5850	36
Norway					5470-5725	30	5725-5795, 5815-5850	54
Oman					5470-5725	30	5725-5850	36
Pakistan							5735-5835	30
Panama							5735-5835	30
Papua New Guinea							5735-5835	30
Peru	5150-5250	49	5250-5350	30	5470-5725	30	5725-5850	36
Philippines	5150-5250	49	5250-5350	30	5470-5725	30	5725-5850	36
Portugal					5470-5725	30	5725-5875	36
Puerto Rico (U.S. territory)			5250-5350	30	5470-5600, 5650-5725	30	5725-5850	54
Qatar							5735-5835	30
Russia					5470-5725	23	5725-5850	23
Singapore							5735-5835	30
South Africa					5470-5725	30	5725-5850	36
Spain					5470-5725	30	5725-5795, 5815-5855	36
Switzerland					5470-5725	30	5725-5795, 5815-5855	36
Taiwan			5250-5350	30	5490-5710	30	5735-5815	30
Thailand			5250-5350	30	5470-5725	30	5725-5850	36
Trinidad And Tobago					5470-5725	30	5725-5850	36
United Kingdom					5470-5725	30	5725-5790, 5815-5850	36
United States	5150-5250	49	5250-5350	30	5470-5600, 5650-5725	30	5725-5850	54
Uruguay					5470-5725	30	5725-5850	36
Uzbekistan					5470-5725	30	5725-5850	36
Venezuela	5150-5250	49	5250-5350	30			5735-5835	30

The following table lists the maximum transmit output power (EIRP) for the 5.1 GHz band.

5.1 GHz Band		Maximum EIRP in dBm
Channel Bandwidth	Frequency Range (Band Edges in MHz)	
10 MHz	5155-5175	39
	5166-5186	44
	5177-5250	49
20 MHz	5156-5180	37
	5161-5185	39
	5166-5209	44
	5190-5250	49
30 MHz	5155-5192	39
	5163-5202	44
	5173-5211	39
	5182-5250	49
40 MHz	5155-5204	39
	5165-5219	39
	5180-5228	44
	5189-5250	49
50 MHz	5155-5214	39
	5165-5233	39
	5184-5242	44
	5193-5250	49

RoHS/WEEE Compliance Statement



English

European Directive 2002/96/EC requires that the equipment bearing this symbol on the product and/or its packaging must not be disposed of with unsorted municipal waste. The symbol indicates that this product should be disposed of separately from regular household waste streams. It is your responsibility to dispose of this and other electric and electronic equipment via designated collection facilities appointed by the government or local authorities. Correct disposal and recycling will help prevent potential negative consequences to the environment and human health. For more detailed information about the disposal of your old equipment, please contact your local authorities, waste disposal service, or the shop where you purchased the product.

Deutsch

Die Europäische Richtlinie 2002/96/EC verlangt, dass technische Ausrüstung, die direkt am Gerät und/oder an der Verpackung mit diesem Symbol versehen ist, nicht zusammen mit unsortiertem Gemeindeabfall entsorgt werden darf. Das Symbol weist darauf hin, dass das Produkt von regulärem Haushaltsmüll getrennt entsorgt werden sollte. Es liegt in Ihrer Verantwortung, dieses Gerät und andere elektrische und elektronische Geräte über die dafür zuständigen und von der Regierung oder örtlichen Behörden dazu bestimmten Sammelstellen zu entsorgen. Ordnungsgemäßes Entsorgen und Recyceln trägt dazu bei, potentielle negative Folgen für Umwelt und die menschliche Gesundheit zu vermeiden. Wenn Sie weitere Informationen zur Entsorgung Ihrer Altgeräte benötigen, wenden Sie sich bitte an die örtlichen Behörden oder städtischen Entsorgungsdienste oder an den Händler, bei dem Sie das Produkt erworben haben.

Español

La Directiva 2002/96/CE de la UE exige que los equipos que lleven este símbolo en el propio aparato y/o en su embalaje no deben eliminarse junto con otros residuos urbanos no seleccionados. El símbolo indica que el producto en cuestión debe separarse de los residuos domésticos convencionales con vistas a su eliminación. Es responsabilidad suya desechar este y cualesquiera otros aparatos eléctricos y electrónicos a través de los puntos de recogida que ponen a su disposición el gobierno y las autoridades locales. Al desechar y reciclar correctamente estos aparatos estará contribuyendo a evitar posibles consecuencias negativas para el medio ambiente y la salud de las personas. Si desea obtener información más detallada sobre la eliminación segura de su aparato usado, consulte a las autoridades locales, al servicio de recogida y eliminación de residuos de su zona o pregunte en la tienda donde adquirió el producto.

Français

La directive européenne 2002/96/CE exige que l'équipement sur lequel est apposé ce symbole sur le produit et/ou son emballage ne soit pas jeté avec les autres ordures ménagères. Ce symbole indique que le produit doit être éliminé dans un circuit distinct de celui pour les déchets des ménages. Il est de votre responsabilité de jeter ce matériel ainsi que tout autre matériel électrique ou électronique par les moyens de collecte indiqués par le gouvernement et les pouvoirs publics des collectivités territoriales. L'élimination et le recyclage en bonne et due forme ont pour but de lutter contre l'impact néfaste potentiel de ce type de produits sur l'environnement et la santé publique. Pour plus d'informations sur le mode d'élimination de votre ancien équipement, veuillez prendre contact avec les pouvoirs publics locaux, le service de traitement des déchets, ou l'endroit où vous avez acheté le produit.

Italiano

La direttiva europea 2002/96/EC richiede che le apparecchiature contrassegnate con questo simbolo sul prodotto e/o sull'imballaggio non siano smaltite insieme ai rifiuti urbani non differenziati. Il simbolo indica che questo prodotto non deve essere smaltito insieme ai normali rifiuti domestici. È responsabilità del proprietario smaltire sia questi prodotti sia le altre apparecchiature elettriche ed elettroniche mediante le specifiche strutture di raccolta indicate dal governo o dagli enti pubblici locali. Il corretto smaltimento ed il riciclaggio aiuteranno a prevenire conseguenze potenzialmente negative per l'ambiente e per la salute dell'essere umano. Per ricevere informazioni più dettagliate circa lo smaltimento delle vecchie apparecchiature in Vostro possesso, Vi invitiamo a contattare gli enti pubblici di competenza, il servizio di smaltimento rifiuti o il negozio nel quale avete acquistato il prodotto.

Appendix E: Declaration of Conformity

Česky [Czech]	UBIQUITI NETWORKS tímto prohlašuje, že tento UBIQUITI NETWORKS device, je ve shodě se základními požadavky a dále tímto prohlašuje, že splňuje ustanovení směrnice 1999/5/ES.
Dansk [Danish]	Undertegnede UBIQUITI NETWORKS erklærer herved, at følgende udstyr UBIQUITI NETWORKS device, overholder de væsentlige krav og øvrige relevante krav i direktiv 1999/5/EF.
Nederlands [Dutch]	Hierbij verklaart UBIQUITI NETWORKS dat het toestel UBIQUITI NETWORKS device, in overeenstemming is met de essentiële eisen en de andere relevante bepalingen van richtlijn 1999/5/EG. Bij deze verklaart UBIQUITI NETWORKS dat deze UBIQUITI NETWORKS device, voldoet aan de essentiële eisen en aan de overige relevante bepalingen van Richtlijn 1999/5/EC.
English	Hereby, UBIQUITI NETWORKS, declares that this UBIQUITI NETWORKS device, is in compliance with the essential requirements and other relevant provisions of Directive 1999/5/EC.
Eesti [Estonian]	Käesolevaga kinnitab UBIQUITI NETWORKS seadme UBIQUITI NETWORKS device, vastavust direktiivi 1999/5/EÜ põhinõuetele ja nimetatud direktiivist tulenevatele teistele asjakohastele sätetele.
Suomi [Finnish]	UBIQUITI NETWORKS vakuuttaa täten että UBIQUITI NETWORKS device, tyypinen laite on direktiivin 1999/5/EY oleellisten vaatimusten ja sitä koskevien direktiivin muiden ehtojen mukainen.
Français [French]	Par la présente UBIQUITI NETWORKS déclare que l'appareil UBIQUITI NETWORKS device est conforme aux exigences essentielles et aux autres dispositions pertinentes de la directive 1999/5/CE.
Deutsch [German]	Hiermit erklärt UBIQUITI NETWORKS, dass sich dieses UBIQUITI NETWORKS Gerät in Übereinstimmung mit den grundlegenden Anforderungen und den anderen relevanten Vorschriften der Richtlinie 1999/5/EG befindet. (BMW)
Ελληνική [Greek]	ΜΕ ΤΗΝ ΠΑΡΟΥΣΑ UBIQUITI NETWORKS ΔΗΛΩΝΕΙ ΟΤΙ UBIQUITI NETWORKS device, ΣΥΜΜΟΡΦΩΝΕΤΑΙ ΠΡΟΣ ΤΙΣ ΟΥΣΙΩΔΕΙΣ ΑΠΑΙΤΗΣΕΙΣ ΚΑΙ ΤΙΣ ΛΟΙΠΕΣ ΣΧΕΤΙΚΕΣ ΔΙΑΤΑΞΕΙΣ ΤΗΣ ΟΔΗΓΙΑΣ 1999/5/ΕΚ.
Magyar [Hungarian]	Alulírott, UBIQUITI NETWORKS nyilatkozom, hogy a UBIQUITI NETWORKS device, megfelel a vonatkozó alapvető követelményeknek és az 1999/5/EC irányelv egyéb előírásainak.
Íslenska [Icelandic]	Hér með tilkynni ég UBIQUITI NETWORKS yfir ví a UBIQUITI NETWORKS device, er í samræmi við grunnkröfur og a rar kröfur, sem gerar eru í tilskipun 1999/5/EC.
Italiano [Italian]	Con la presente UBIQUITI NETWORKS dichiara che questo UBIQUITI NETWORKS device, è conforme ai requisiti essenziali ed alle altre disposizioni pertinenti stabilite dalla direttiva 1999/5/CE.
Latviski [Latvian]	Ar o UBIQUITI NETWORKS deklarē, ka UBIQUITI NETWORKS ierīce, atbilst Direktīvas 1999/5/EK būtiskajām prasībām un citiem ar to saistītajiem noteikumiem.
Lietuviškai [Lithuanian]	UBIQUITI NETWORKS deklaruoja, kad šis UBIQUITI NETWORKS įrenginys atitinka esminius reikalavimus ir kitas 1999/5/EB Direktyvos nuostatas.
Malti [Maltese]	Hawnhekk, UBIQUITI NETWORKS, jiddikjara li dan UBIQUITI NETWORKS device, jikkonforma mal- ti ijjiet essenzjali u ma provvedimenti o rajn rilevanti li hemm fid-Direttiva 1999/5/EC.
Norsk [Norwegian]	UBIQUITI NETWORKS erklærer herved at utstyret UBIQUITI NETWORKS device, er i samsvar med de grunnleggende krav og øvrige relevante krav i direktiv 1999/5/EF.
Slovensky [Slovak]	UBIQUITI NETWORKS týmto vyhlasuje, že UBIQUITI NETWORKS device, spĺňa základné požiadavky a v etky príslušné ustanovenia Smernice 1999/5/ES.

Svenska [Swedish]	Härmed intygar UBIQUITI NETWORKS att denna UBIQUITI NETWORKS device, står i överensstämmelse med de väsentliga egenskapskrav och övriga relevanta bestämmelser som framgår av direktiv 1999/5/EG.
Español [Spanish]	Por medio de la presente UBIQUITI NETWORKS declara que el UBIQUITI NETWORKS device, cumple con los requisitos esenciales y cualesquiera otras disposiciones aplicables o exigibles de la Directiva 1999/5/CE.
Polski [Polish]	Niniejszym, firma UBIQUITI NETWORKS o wiadcza, że produkt serii UBIQUITI NETWORKS device, spełnia zasadnicze wymagania i inne istotne postanowienia Dyrektywy 1999/5/EC.
Português [Portuguese]	UBIQUITI NETWORKS declara que este UBIQUITI NETWORKS device, está conforme com os requisitos essenciais e outras disposições da Directiva 1999/5/CE.
Română [Romanian]	Prin prezenta, UBIQUITI NETWORKS declară că acest dispozitiv UBIQUITI NETWORKS este în conformitate cu cerințele esențiale și alte prevederi relevante ale Directivei 1999/5/CE.

Appendix F: Contact Information

Ubiquiti Networks Support

Ubiquiti Support Engineers are located around the world and are dedicated to helping customers resolve software, hardware compatibility, or field issues as quickly as possible. We strive to respond to support inquiries within a 24-hour period.

Online Resources

Support: support.ubnt.com

Community: community.ubnt.com

Downloads: downloads.ubnt.com



2580 Orchard Parkway
San Jose, CA 95131
www.ubnt.com

©2015 Ubiquiti Networks, Inc. All rights reserved. Ubiquiti, Ubiquiti Networks, the Ubiquiti U logo, the Ubiquiti beam logo, airFiber, airOS, RocketDish, TOUGH Cable, and xRT are trademarks or registered trademarks of Ubiquiti Networks, Inc. in the United States and in other countries. All other trademarks are the property of their respective owners.