

150W AC/DC Power Supply Unit Instruction Manual

Document Part Number: IM-Z1286

Revision: 06

Issue Date: July 10, 2013

Copyright © 2010, New Japan Radio Co., Ltd. All rights reserved.
This instruction manual may not be reproduced, in part or in whole,
without the permission of New Japan Radio Co., Ltd.

The specifications and information regarding the products in this
instruction manual are subject to change without notice.

All statements, information, and recommendations in this
instruction manual are believed to be accurate but are presented
without warranty of any kind, express, or implied.

Users must take full responsibility for their application of any
products.

Revision Record

REV	DESCRIPTION	DATE
01	Initial Release (for Engineering Sample)	January 28, 2010
02	Revised for production	August 20, 2010
03	Revised at Connection and Installation	December 16, 2010
04	•Add Note: 1, Change of Note No(Note:1→2,Note:2→3) •3. Packing List: Delete of No6 Coaxial cable, Change of List No(7→6,8→7,9→8,) •6.2.1. AC Power Cable Add Note	November 09,2011
05	Rack-mount kit revised	December 18, 2012
06	Added the BUC line-up of NJT5763NA and NJT5763FA	July 10,2013

General Caution



1. NJRC strives to produce reliable and high quality microwave components. NJRC's microwave components are intended for specific applications and require proper maintenance and handling. To enhance the performance and service of NJRC's microwave components, the devices, machinery or equipment into which they are integrated should undergo preventative maintenance and inspection at regularly scheduled intervals. Failure to properly maintain equipment and machinery incorporating these products can result in catastrophic system failures.
2. To ensure the highest levels of reliability, NJRC products must always be properly handled. The introduction of external contaminants (e.g. dust, oil or cosmetics) can result in failures of microwave components.
3. NJRC offers a variety of microwave components intended for particular applications. It is important that you select the proper component for your intended application. You may contact NJRC's sales office or sales representatives, if you are uncertain about the products listed in the catalog and the specification sheets.
4. Special care is required in designing devices, machinery or equipment, which demand high levels of reliability. This is particularly important when designing critical components or systems whose foreseeable failure can result in situations that could adversely affect health or safety. In designing such critical devices, equipment or machinery, careful consideration should be given to, amongst other things, their safety design, fail-safe design, back-up and redundancy systems, and diffusion design.
5. The products listed in the catalog and specification sheets may not be appropriate for use in certain equipment where reliability is critical or where the products may be subjected to extreme conditions. You should consult our sales office or sales representatives before using the products in any of the following types of equipment.
 - * Aerospace Equipment
 - * Equipment Used in the Deep Sea
 - * Power Generator Control Equipment (nuclear, steam, hydraulic)
 - * Life Maintenance Medical Equipment
 - * Fire Alarm/Intruder Detector
 - * Vehicle Control Equipment (automobile, airplane, railroad, ship, etc.)
 - * Various Safety Equipment

General Caution (countined)

6. NJRC's products have been designed and tested to function within controlled environmental conditions. Do not use products under conditions that deviate from methods or applications specified in the catalog and specification sheets. Failure to employ NJRC's products in the proper applications can lead to deterioration, destruction or failure of the products. NJRC shall not be responsible for any bodily injury, fires or accidents, property damage or any consequential damages resulting from the misuse or misapplication of its products. PRODUCTS ARE SOLD WITHOUT WARRANTY OF ANY OF KIND, EITHER EXPRESS OR IMPLIED, INCLUDING BUT NOT LIMITED TO ANY IMPLIED WARRANTY OF MERCHANTABILITY OR FITNESS FOR A PARTICULAR PURPOSE.

About This Instruction Manual

This instruction manual describes 150W AC/DC Power Supply Unit (PSU) for NJRC's C-band 10W and Ku-band 8W BUC (Model No.: NJT5762N, NJT5762F, NJT5763N, NJT5763F, NJT5118N, NJT5118F, NJT5218N, and NJT5218F) herein referred to as "the Unit".

This instruction manual provides information and instructions for installation and operation of the Unit.

This instruction manual is intended for use by trained field installers or system engineers responsible for satellite networks.

Updated instruction manual may be available from NJRC's sales group mcsales@njr.co.jp.

Contents

1. Introduction	6
2. Safety Instructions	7 - 9
3. Packing List	10
4. Overview	11 - 12
5. Physical Description	13 - 17
6. Connection and Installation	18 - 25
7. Maintenance	26 - 30
8. Specification	31 - 32

1. Introduction

This instruction manual is for 150W AC/DC PSU for NJRC's C-band 10W and Ku-band 8W BUC (Model No.: NJT5762N, NJT5762F, NJT5763N, NJT5763F, NJT5118N, NJT5118F, NJT5218N, and NJT5218F).

The Unit is constructed by a 150W AC/DC power supply and a bias-tee which applies +48 V DC power and passes through 10 MHz reference and IF signal (L-band: 950 - 1450 MHz or 950 - 1750 MHz).

The Unit comes in an aluminium-housing with corrosion-proof treatment, assuming the indoor use. The Unit receives and transmits 10 MHz reference and IF signal (L-Band: 950 - 1450 MHz or 950 - 1750 MHz). The Unit supply +48 V DC power on a output connector. The Unit has N-Type or F-type connectors input for 10 MHz reference and IF signal, output for DC power, 10 MHz reference and IF signal, and IEC320-C14 inlet input for AC power (100 to 240 VAC).

1.1. Model Number



Model Number	Product Model Number	
	BUC	150W AC/DC PSU
NJT5762NA	NJT5762N	NJZ1286N
NJT5762FA	NJT5762F	NJZ1286F
NJT5763NA	NJT5763N	NJZ1286N
NJT5763FA	NJT5763F	NJZ1286F
NJT5118NA	NJT5118N	NJZ1286N
NJT5118FA	NJT5118F	NJZ1286F
NJT5218NA	NJT5218N	NJZ1286N
NJT5218FA	NJT5218F	NJZ1286F



2. Safety Instructions

Use the following safety guidelines to help protect the Unit from potential damage and to help ensure your own personal safety.

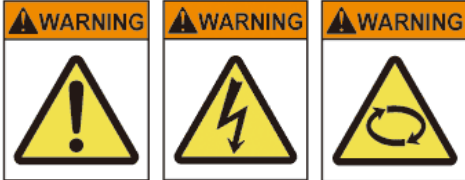
DANGER, WARNING, CAUTION, and NOTE Statements

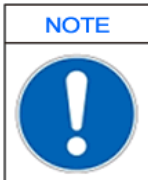
DANGER, WARNING, CAUTION, and NOTE statements are used throughout this instruction manual to emphasize important and critical information. You must read these statements to help ensure safety and to prevent product damage. The statement are defined below.

<i>Statement</i>	<i>Symbol</i>	<i>Description</i>
DANGER		DANGER indicates an imminently hazardous situation which, if not avoided, will result in death or serious injury.
WARNING		WARNING indicates a potentially hazardous situation which, if not avoided, could result in death or serious injury.
CAUTION		CAUTION indicates a potentially hazardous situation which, if not avoided, could result in minor or moderate injury. CAUTION may also be used to indicate other unsafe practices or risks of property damage.
NOTE		NOTE is used to notify of installation, operation, or maintenance information that is important, but not hazard-related.

Symbol	Description
	GENERIC HAZARD
	ELECTRIC HAZARD
	MOVING PARTS

When installing the Unit, observe the following safety guidelines.





2.1. Safety Statements

1.  DO NOT dismantle this product except disinstallation of the fan. Dismantlement may cause malfunction and electric shock.



2.  DO NOT use the Unit beyond the specifications of AC power supply range; 100 to 240 VAC at 50 or 60 Hz. Incorrect usage may cause fire / malfunction.

3.  DO NOT insert your finger into the fan to avoid injury.

4.  DO NOT insert any objects into the fan. Keep any objects away from the fan. Incorrect usage may cause injury to self or others.

- | | | |
|----|--|---|
| 5. |  | DO NOT connect the coaxial cable which is output from the Tx port of modem or IDU to the IF/Ref./DC+48V output port, as this can result to break down the modem or IDU. |
| 6. |  | To reduce the electrical damage of the Unit, apply a voltage other than +24 and +48 V on the IF/Ref./ (DC) input port. |
| 7. |  | Install the Unit to indoor under specified temperature and humidity.
Using in outdoor and indoor under the environment other than specified temperature and humidity may cause fire / malfunction. |
| 8. |  | To reduce the risk of fire or electrical shock, do not expose this product to rain or moisture. |

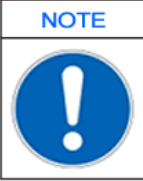
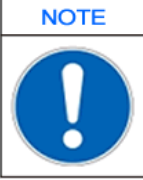
2.2. Instruction Statements

- | | | |
|----|---|---|
| 1. | <p>NOTE</p>  | Statement indicating that the socket-outlet shall be installed near the equipment and shall be easily accessible. |
| 2. | <p>NOTE</p>  | The fan has its lifetime. The fan is to be replaced with a new one at appropriate interval.
The recommendation interval of replacement is 5 years. |
| 3. | <p>NOTE</p>  | Keep excess sand / dirt away from the Unit, especially ventilation slit on sides and around the fan.
Irrelevant treatment may shorten the lifetime of the fan. |

3. Packing List

The Unit is shipped in a single shipping container with the following contents:

No.	Qty	Description
1.	1 unit	BUC C-band 10W BUC: (Model No.: NJT5762N, NJT5762F, NJT5763N, or NJT5763F OR Ku-band 8W BUC (Model No.: NJT5118N, NJT5118F, NJT5218N, or NJT5218F)
2.	1 set	Accessory of BUC In case of Full/C-band 10W BUC Qty(1), O-ring In case of Ku-band 8W BUC Qty(4), Hexagon Socket Head Bolt (M4x10) Qty(1), Hexagon Wrench Key (M4) Qty(1), O-ring
3.	1 sheet	Datesheet for BUC
4.	1 unit	150W AC/DC Power Supply Unit (PSU) N-type connector: NJZ1286N OR F-type connector: NJZ1286F
5.	1 piece	AC cable with 3 pins American plug and IEC320-C13 outlet (Length: 2 m)
6.	4 pieces	Rubber Foot (3M™ Bumpon™)
7.	1 set	Rack-mount kit (Optional)
8.	1 copy	Instruction Manual (This document)

4. Overview

The Unit provides a DC power via a coaxial cable to operate NJRC's Full/C-band 10W and Ku-band 8W BUC.

Unique features:

- Indoor power supply unit with up to 150 W and +48 V DC power output.
- For any types of modem.
- DC power output can be turned on/off by mechanical switch on the front
- The mode of DC power output can be selected out of in the following mode options by DIP switch on the front panel.

Option 1: To keep supplying DC power regardless of modem output status.

Option 2: To control power DC output on/off by synchronization of input DC voltage on/off from modem.

- Directly connect the coaxial cable for IF signal, 10 MHz reference and DC power from modem.
- One coaxial cable solution.
- Compatible with 1U rack-mount.

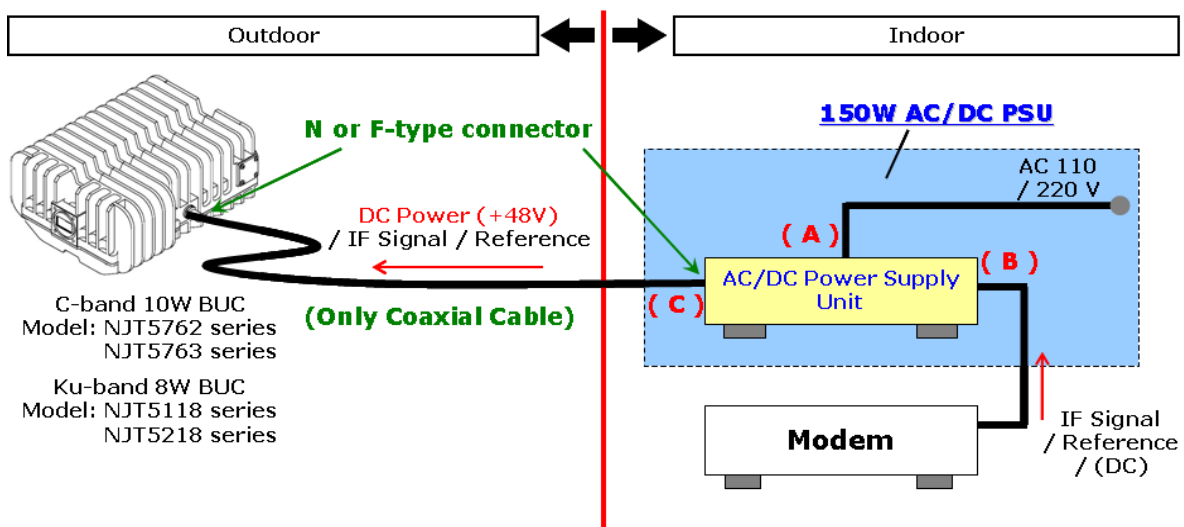
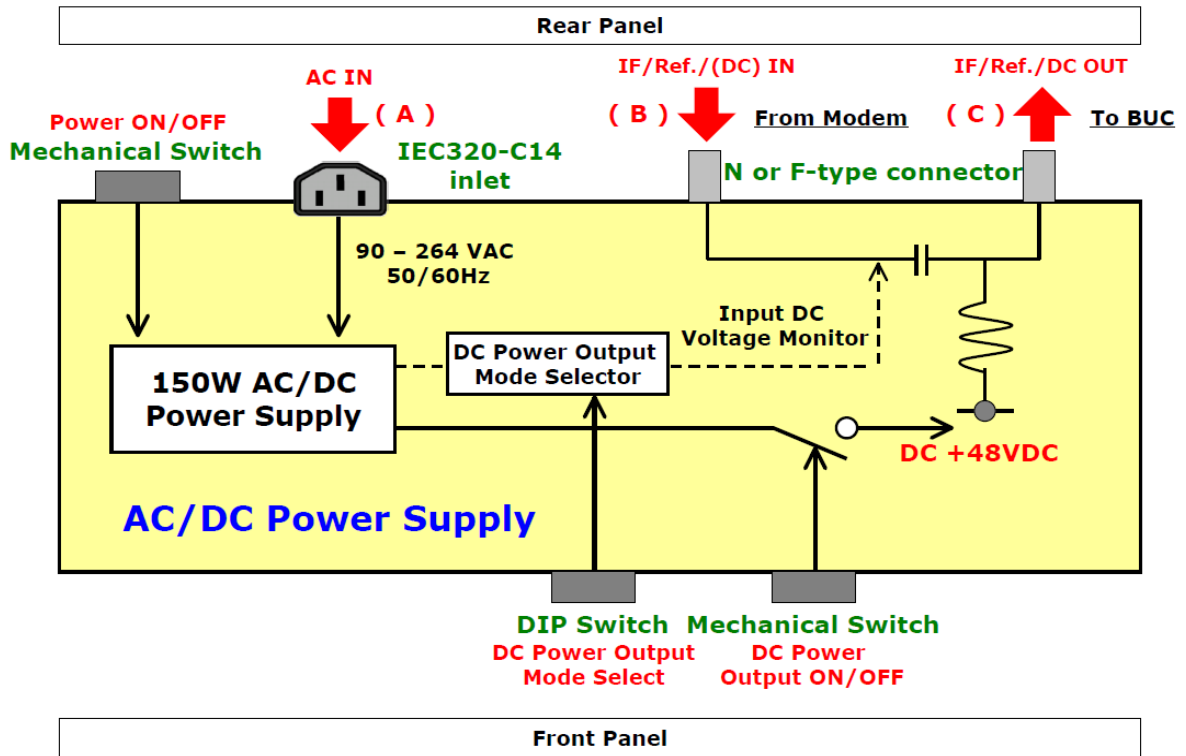

Diagram of Connecting among Modem, BUC, and 150W AC/DC PSU



Schematic Diagram of Inside AC/DC Power Supply

5. Physical Description

This section describes appearance and outline of the Unit.

5.1. Appearance



Front View of 150W AC/DC PSU



**Rear View of 150W AC/DC PSU
(N-type Female Connector Model)**

5.2. Outline

UNIT : mm

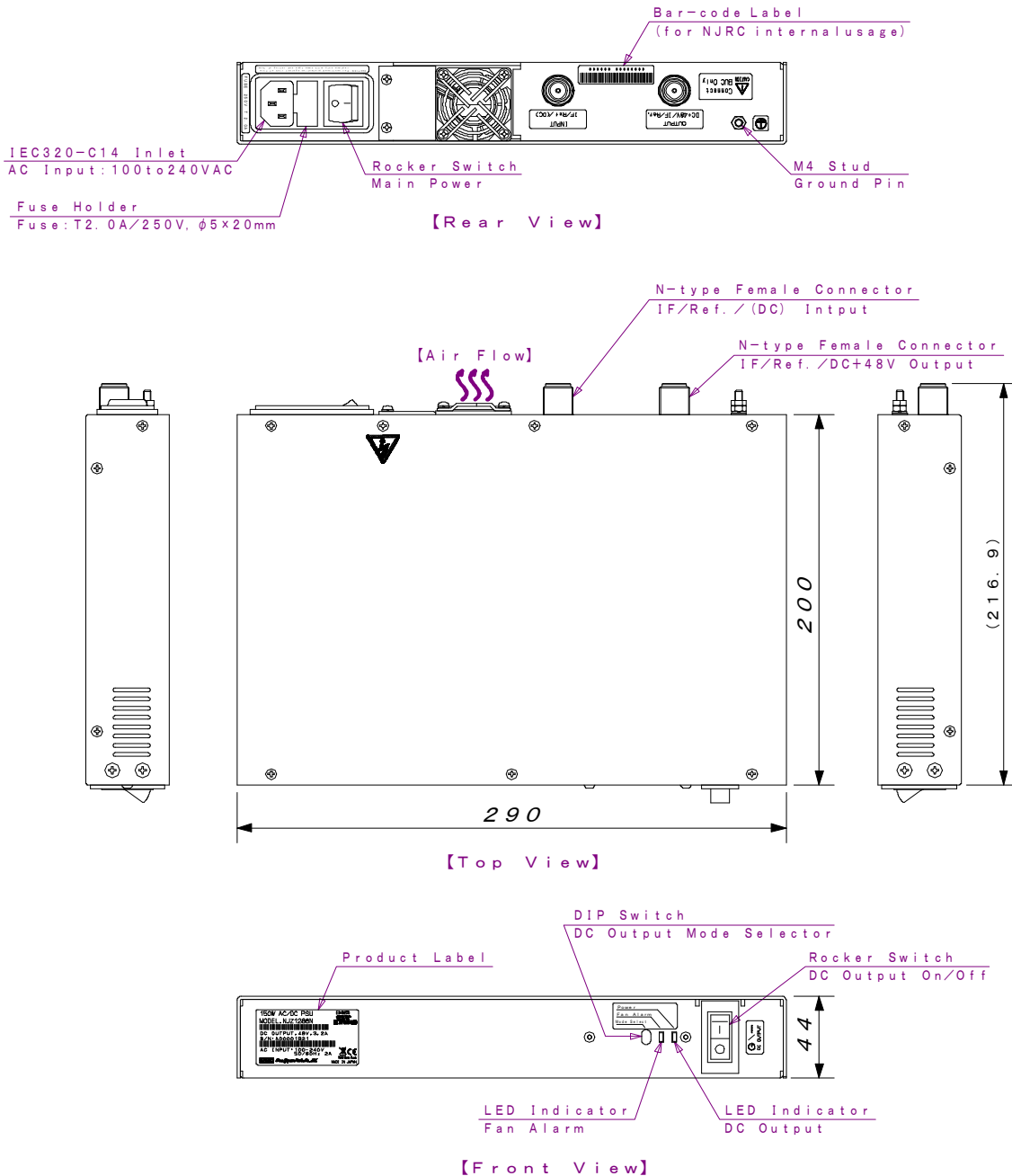

**Dimensions
(N-type Female Connector Model)**

UNIT : mm

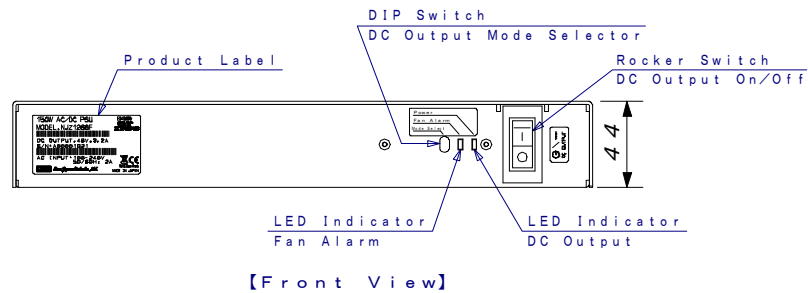
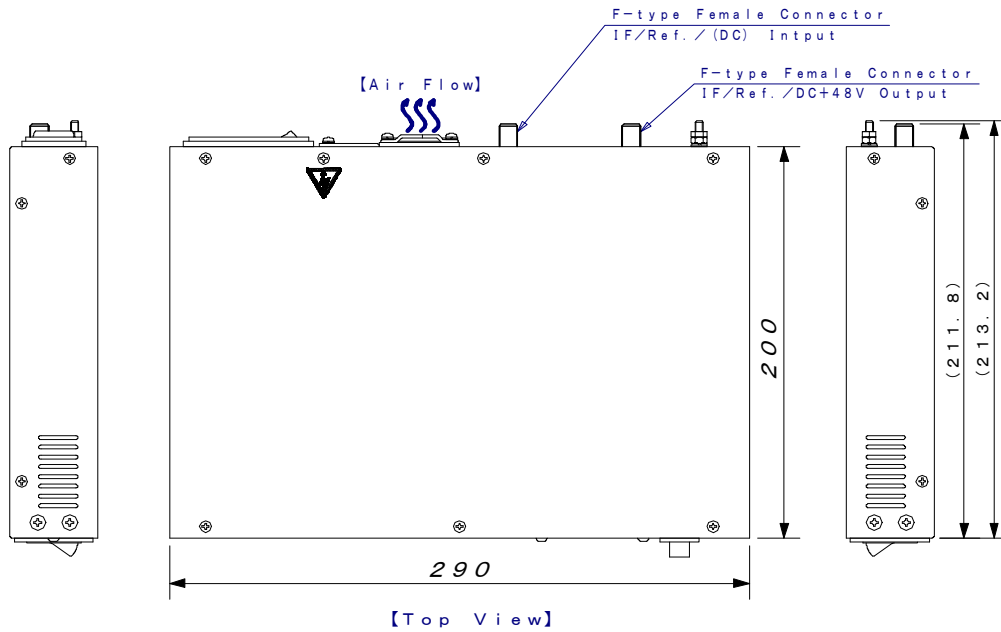
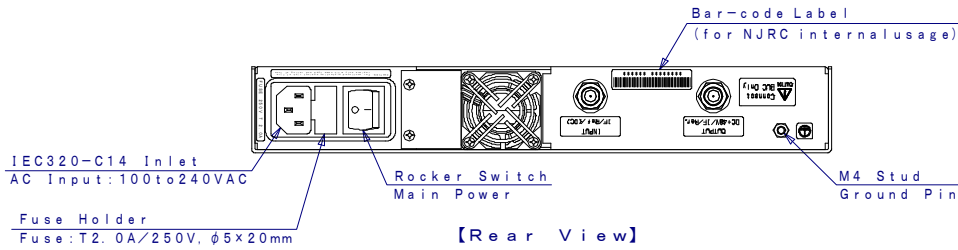

Dimensions (F-type Female Connector Model)

5.3. Description of Connectors, Switches, and LEDs

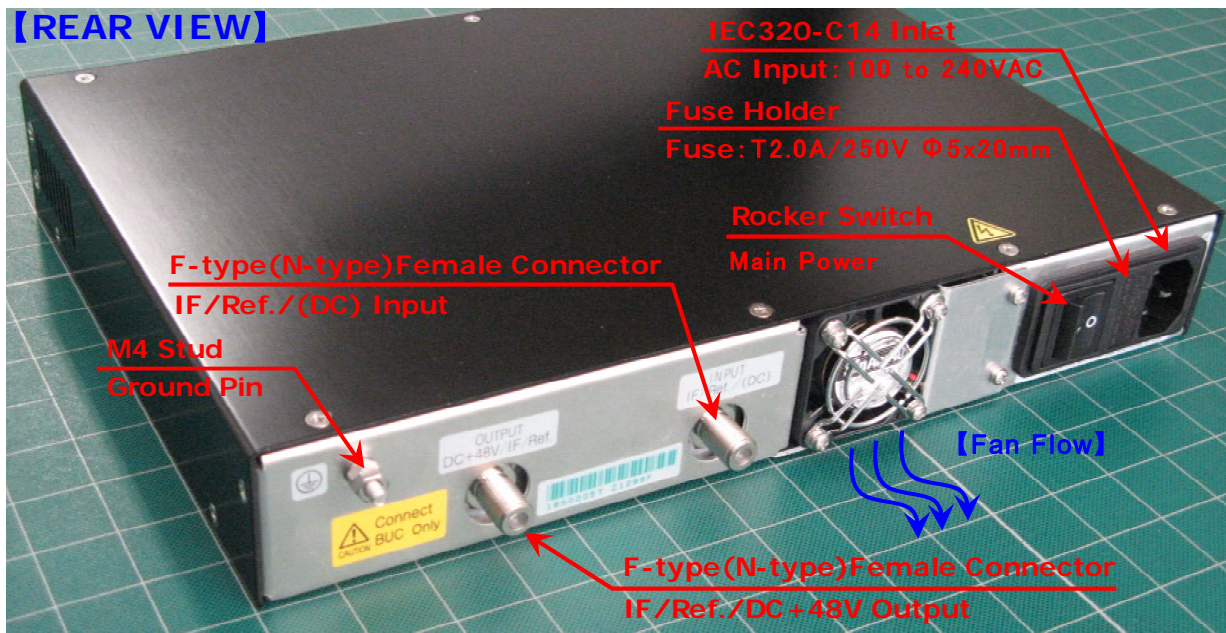
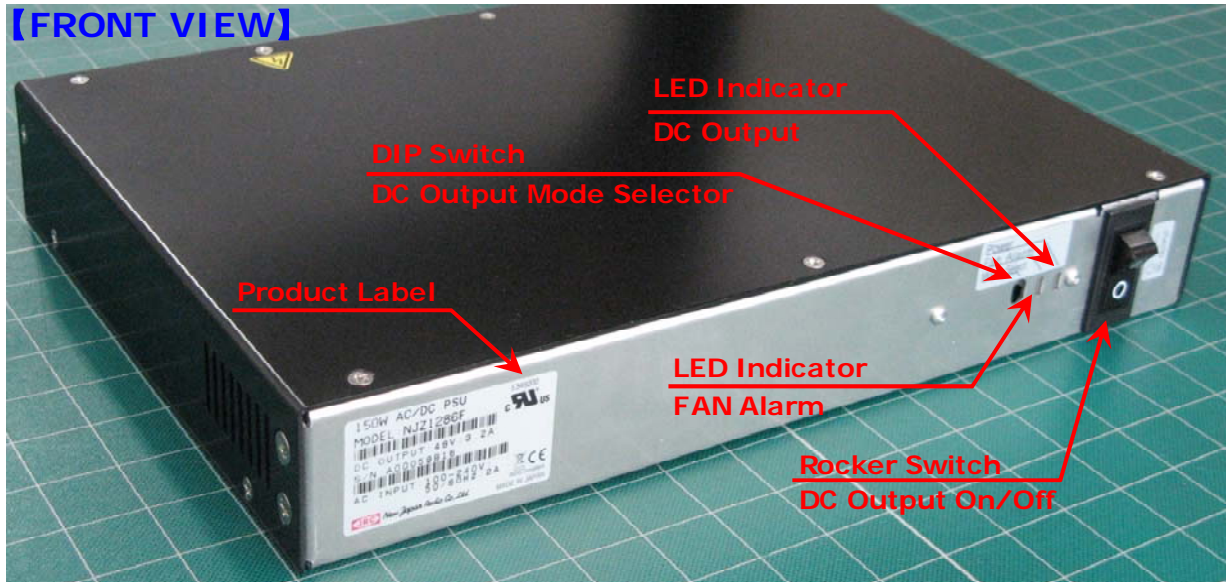

Description of Connectors, Switches, and LEDs

Item	Description	Purpose
AC Input	IEC320-C14 inlet	100 to 240 V AC power input.
Main Power	Rocker Switch	Input AC power on/off set.
Fuse Holder	Fuse	The Unit is fitted with two fuse - one for AC line connection, and other one for replacement. Fuse Type: T2.0A/250V, $\phi 5 \times 20$ mm
IF/Ref./(DC) Input	N-type Female OR F-type Female	Transmit signal (IF signal and 10 MHz reference) from modem or IDU. Possible directly to connect the coaxial cable with +24 / +48 V DC power from modem.
IF/Ref./(DC) Output	N-type Female OR F-type Female	Transmit signal (IF signal and 10 MHz reference) and supply +48 V DC power to BUC.
Ground Pin	M4 Stud	Common chassis ground
DC Output On/Off	Rocker Switch	Internal output DC power on/off set. Possible to protect the unit from short damage of DC output on the circuit protection in this switch
DC Output	LED Indicator	Green: DC power output from AC/DC power supply No lighting: No DC power output from AC/DC power supply
Fan Alarm	LED Indicator	Green: Fan operating Red: Non fan operating
DC Output Mode Selector	DIP Switch	The mode of DC power output can be selected by customer in following two mode options by DIP switch on front panel. Option 1 (default setting): To keep supplying DC power regardless of modem output status. Option 2: To control DC power output on/off by synchronization of input DC voltage on/off from modem.

6. Connection and Installation

This section describes basic installation for the Unit.

6.1. Setting

Two setting ways:

- Desktop / Shelf mount
- Rack-mount (optional rack-mount kit is available)

6.1.1. Guidelines for Desktop / Shelf Mount

When installing the Unit, you should follow the following guidelines:

- Check the site location for factors such as accessibility, power, signal, and cable connections for modem / BUC, and future expansion.
- Plan for access to both front and rear of the Unit.
- Ensure the room where the Unit operates has adequate ventilation around the fan on rear panel and the slit on both sides. Ambient air temperature may not cool the Unit to acceptable operating temperatures without adequate ventilation.
- If the Unit is mounted in an enclosed shelf, ensure that the shelf has adequate ventilation. An enclosed shelf should have air opening on rear panel and both sides and to provide natural convection air movement.
- Attach four pieces of the enclosed rubber foot (3M™ Bumpon™) to four corners on bottom of the Unit as shown in below.

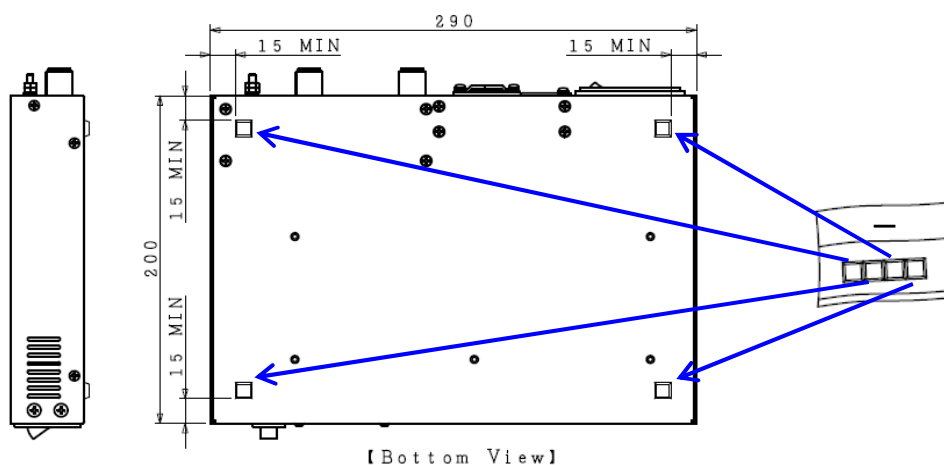

6.1.2. Guidelines for Rack-mount

The Unit can only be flush-mounted in the 19 inch rack using the optional rack-mount kit. The Unit can be mounted with the front of the chassis panel facing outward toward the aisle.

When installing the Unit, you should follow the following guidelines:

- The Unit with the optional rack-mount kit requires a minimum of 1U (44 mm) of vertical rack spaces. You should measure the proposed rack location before mounting the chassis.
- Check the site location for factors such as accessibility, power, signal, and cable connections for modem / BUC, and future expansion.
- Plan for access to both front and rear of the Unit.
- Ensure the room where the Unit operates has adequate ventilation around the fan on rear panel and the slit on both sides. Ambient air temperature may not cool the Unit to acceptable operating temperatures without adequate ventilation.
- If the Unit is mounted in an enclosed shelf, ensure that the shelf has adequate ventilation. An enclosed shelf should have air opening on rear panel and both sides and to provide natural convection air movement.

Flush-mounting the Unit in the 19 inch rack is proceed with the following steps:

Tools Required: #2 phillips screwdriver

Rack-mount Kit (Optional):

No.	Qty	Description
1.	2 pieces	Rack-mount Flange

Step 1: Using #2 phillips screwdriver, remove and save four M4 flat head screws as shown in below.

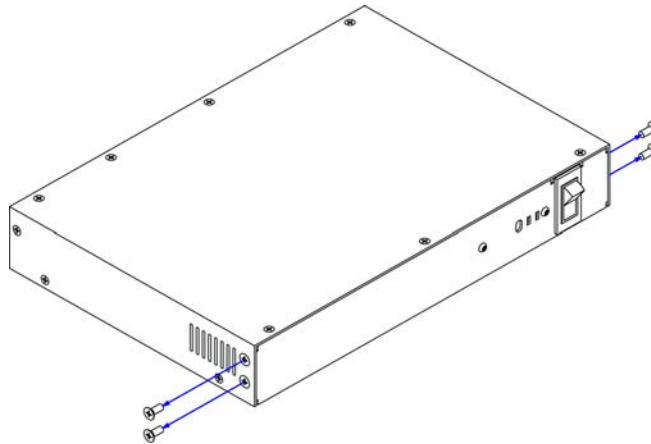

Step 2: Position the rack-mount flanges (Rack-mount Kit: No. 1) both sides of the Unit as shown in below. Install four M4 flat head screws to flanges and the Unit.

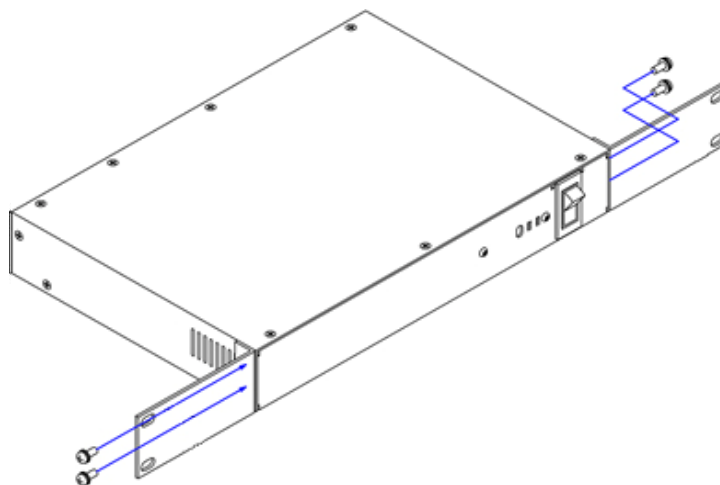

6.2. Connection

Three cables and one wire:

- AC Power Cable
- Coaxial Cable from Modem or IDU to the Unit
- Coaxial Cable from the Unit to BUC
- Wire for Common Chassis Ground

6.2.1. AC Power Cable

The Unit is directly powered by AC power source (100-240V). Low noise / low transient AC power source is recommended.

Connection of AC power cable is to be proceeded as it follows:

Step 1: Check that the rocker switch of "Main Power" on the rear panel and the "DC Output On/Off" on the front panel are to be

Step 2: Connect the AC power cable (3 pins American plug) to IEC320-C14 inlet on the rear panel.
In case of a different type of outlet from 3 pins American plug, employ a conversion plug suitable to the outlet instead.

<p>NOTE</p> 	Statement indicating that the socket-outlet shall be installed near the equipment and shall be easily accessible.
--	---

6.2.2. Coaxial Cable from Modem or IDU to the Unit

10 MHz reference and IF signal (L-band: 950 - 1450 MHz or 950 - 1750 MHz) are input from Modem to BUC by way of the Unit.

Connection of the coaxial cable among modem and the Unit are described by the following steps:

Step 1: Connect a coaxial cable with N-type or F-type male connectors to the IF/Ref./(DC) input port on the rear panel of the Unit as shown in the diagram of subsequent page.

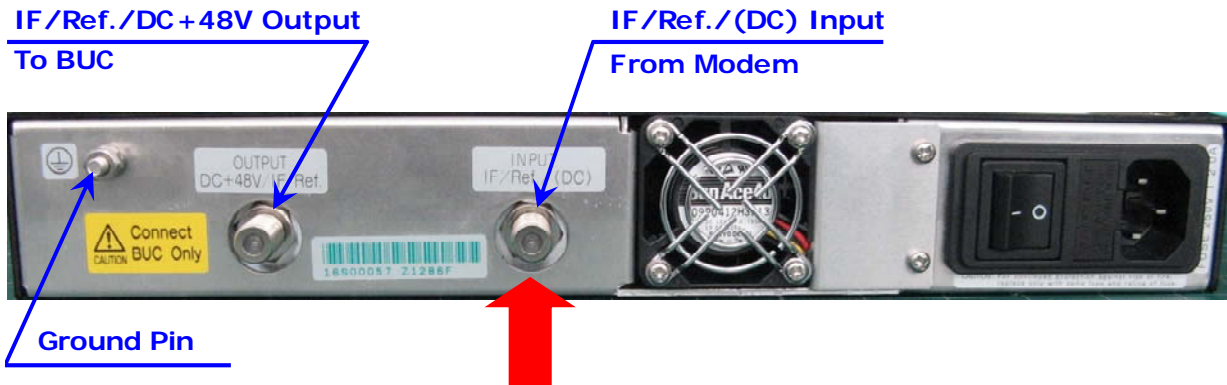

Connect the coaxial cable which connects to the Tx port of modem or IDU.

Step 2: Connect the cable to TX port of modem or IDU.

	<p>In order to prevent the electrical damage of the Unit, apply a voltage other than +24 and +48 V on the IF/Ref./(DC) input port.</p>
---	--

6.2.3. Coaxial Cable from the Unit to BUC

The Unit can be supply +48 V DC power of the internal AC/DC power supply to BUC, and passed through 10 MHz reference, an IF signal (L-band: 950 - 1450 MHz or 950 - 1750 MHz) from modem or IDU to BUC.

Connecting coaxial cable from the Unit to BUC is proceed with the following steps:

Step 1: Connect a coaxial cable with N-type or F-type male connector to the IF/Ref./DC+48V output port on rear panel as shown in below.

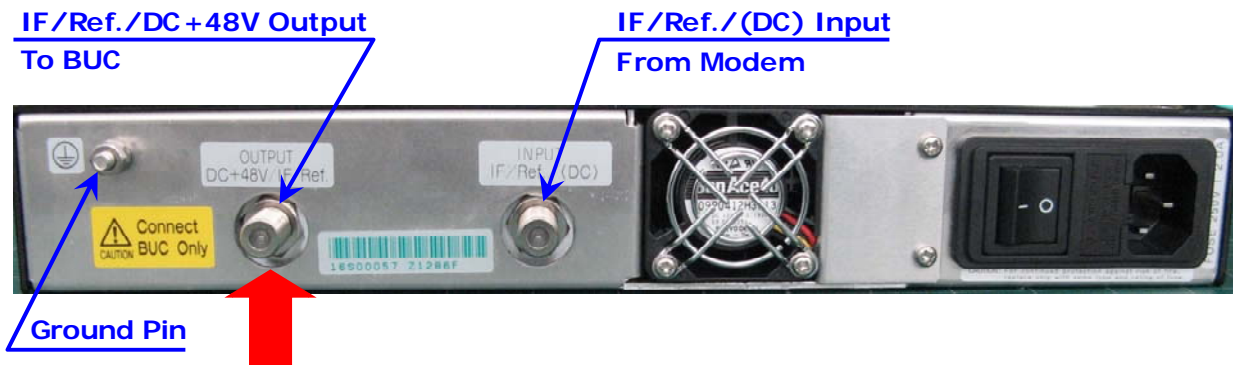

Connect the coaxial cable which connects to the BUC.

Step 2: Connect the cable to BUC.

	DO NOT connect the coaxial cable which is output from the Tx port of modem or IDU to the IF/Ref./DC+48V output port, as this can result to break down the modem or IDU.
---	---

6.2.4. Wire for Common Chassis Ground

The Unit can be had the chassis ground of the other equipment (e.g. modem) in common.

Connecting wire for common chassis ground from the chassis ground of the other equipment is proceed with the following step:

Step: Connect the wire from ground on the other equipment to the ground pin stud on rear panel.

6.3. Configuring the Mode of DC Power Output

The mode of DC power output can be selected by customer in following two mode options:

- Option 1 (default setting): To keep supplying DC power regardless of modem output status.
- Option 2: To control power DC output on/off by synchronization of input DC voltage on/off from modem.

In case of outputting DC power with mode of option 1, you do not need to configure the factory default setting of DIP switch on front panel.

However, if the Unit outputting DC power with mode of option 2, you need to change DIP switch on front panel from top side to bottom side by a pointed jig (e.g. needle) as shown in below

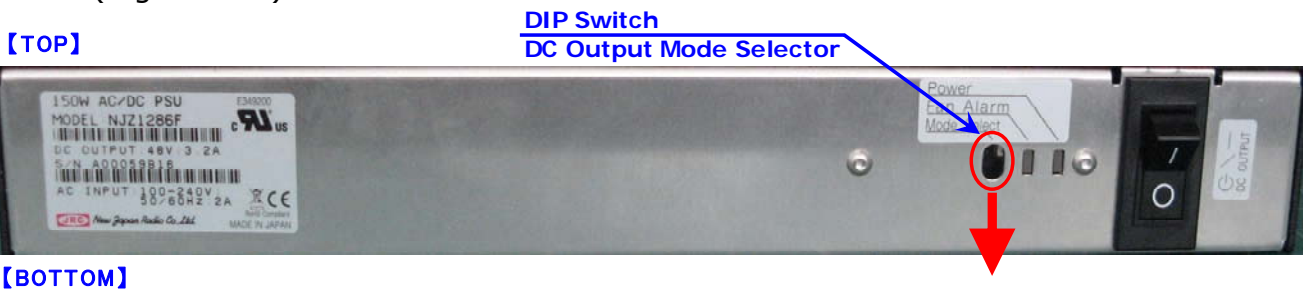

[BOTTOM]

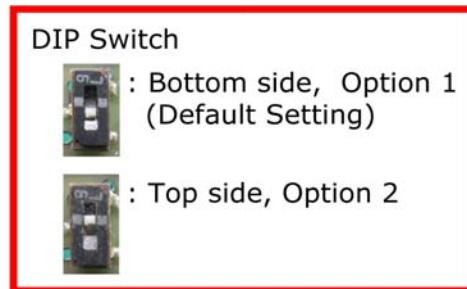

<p>CAUTION</p>	<p>When changing setting of DIP switch, turn off the main power by rocker switch on rear panel and do not use pincette. If changing setting of DIP switch with the Unit operated or by pincette this can result to break down the Unit.</p>
-----------------------	---

6.4. Start-up

Start-up the Unit is proceed with the following steps:

- Step 1: Turn on the rocker switch of the main power on rear panel, then the fan on rear panel starts to circle and LED indicator of the fan alarm on front panel lights green.
- Step 2: Turn on the rocker switch of DC output on/off on front panel, then LED indicator of the DC output on front panel lights green and DC power is output under the DC power output mode.

6.5. Recommendation Coaxial Cable from the Unit to BUC

You need to choose type and length of the coaxial cable from the Unit to BUC to satisfy that the Unit output less than 150 W DC power, and an input voltage of BUC is more than 18 V.

On choice of type and length of the coaxial cable, you need to consider RF insertion loss between the Unit and BUC in accordance with modem or IDU

In terms of satisfying that the Unit output less than 150 W DC power, and an input voltage of BUC is more than 18 V. The following cables which total resistance* is 30 ohms/km or less are recommended:

(*Note: Total resistance means sum number of both conductor and outer shield resistance.)

- RG-6 (Total Resistance: around 30 ohms/km)
- RG-11 (Total Resistance: around 13 ohms/km)

If total resistance of your chosen cable is less than 30 ohms/km, you can install the cable of up to 200m (650 feet) between the unit and BUC.

Contact to us by phone, fax, or email, if further information is needed beyond the coverage of this instruction manual on the recommendation coaxial cable.

- Telephone: +81-49-278-1270
- Fax: +81-49-278-1234
- Email: mcsales@njr.co.jp

7. Maintenance

This Section describes basic maintenance for the Unit.

7.1. Dust Removal

Regular dusting / dust removal will ensure the Unit to operate within operational specification.

- Use a slightly damp cloth with excess moisture wringed out (not saturated, wet or dripping cloth) to wipe away the dust that collects on the outside of the enclosure
- A high, dusty environment will require frequent maintenance of vacuuming the dust off the enclosure vents and circuit board.

7.2. Fan Field Replacement

The Unit is Forced Air by fan on rear panel for cooling.

<p>NOTE</p> 	<p>The fan has its lifetime. The fan is to be replaced with a new one at appropriate interval.</p> <p>The recommendation interval of replacement is 5 years.</p>
--	--

The Unit indicates the fan alarm by LED indicator on front panel with red light emission, you need to replace a new fan by yourself in field. And the fan is to be replaced with a new one at five years interval.

Contact to us by phone, fax, or email, when a new fan for replacement is needed.

- Telephone: +81-49-278-1270
- Fax: +81-49-278-1234
- Email: mcsales@njr.co.jp

The replacement of fan is proceed with the following steps:

	<p>You must be very careful when replacing a fan to avoid being shocked or damaging the circuit. The following safety precautions will protect you and the equipment you are using.</p> <ul style="list-style-type: none"> · Turn the power off, disconnect the AC power cable, and discharge the circuit before removing a fan. · When you remove a fan and fit in a new one , be careful to avoid shocks and short circuits.
---	--

Tools Required: #2 phillips screwdriver

Step 1: Turn off the rocker switch of the main power on rear panel, and disconnect the AC power cable from the Unit.

Step 2: Using #2 phillips screwdriver, remove 6 pan head screws with washers, and save the screws, a finger guard over fan, and a cover over fan cable as shown in below.

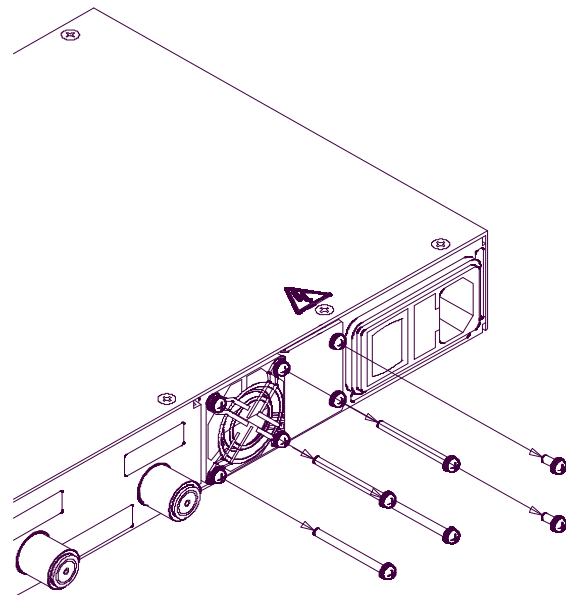
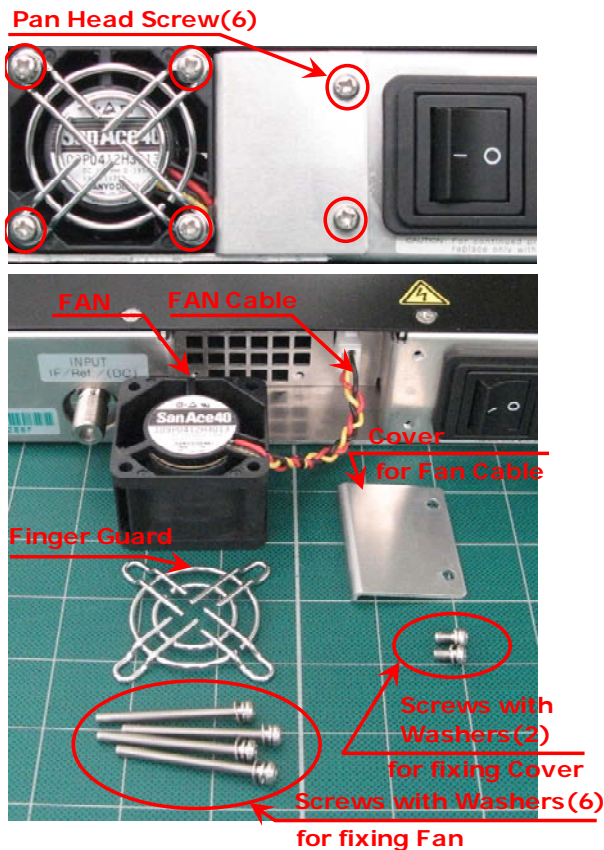

Step 3: Disconnect the fan cable with the original fan that are connected to the Unit as shown in below, and remove the fan from the Unit.

Connector for Fan Cable



Fan



Step 4: Connect the fan cable with new fan to the Unit.
Re-install the 4 pan head screws with washers and the finger guard that were removed.

Step 5: Re-install the 2 pan head screws with washers and the cover that were removed as shown.

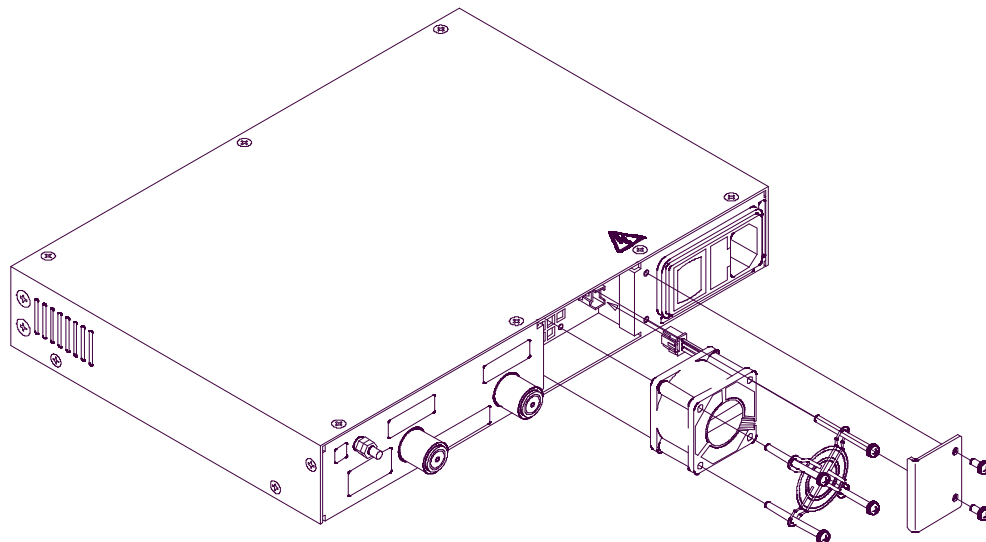

7.3. Fuse Field Replacement

The Unit is fitted with a fuse for AC line connection. The fuse are contained within the holder of the AC power inlet connector, behind a small plastic flap. The Unit has one other fuse for replacement.

· Fuse Type: T2.0A/250V, $\phi 5 \times 20$ mm

If the Unit is overloaded and the fuse is blown, you need to replace a new fuse by yourself in field in order to operate normally.

The replacement of fuse is proceed with the following steps:

	<p>You must be very careful when replacing a fuse to avoid being shocked or damaging the circuit. The following safety precautions will protect you and the equipment you are using.</p> <ul style="list-style-type: none"> · Turn the power off, disconnect the AC power cable, and discharge the circuit before removing a fuse. · When you remove a fuse and fit in a new one , be careful to avoid shocks and short circuits.
---	---

Step 1: Turn off the rocker switch of the main power on rear panel, and disconnect the AC power cable from the Unit.

Step 2: Open the fuse holder next to the IEC320-C14 inlet, and replace in-use fuse (blown fuse) with stock fuse or new one. See figure

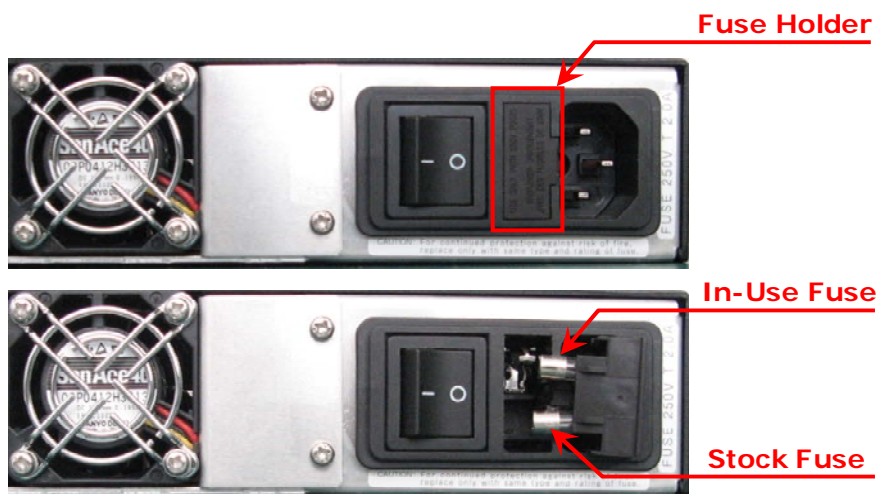

Step 3: Close the fuse holder, connect the AC power cable to the Unit, and Turn on the rocker switch

Contact to us by phone, fax, or email, if further information is needed beyond the coverage of this instruction manual on the maintenance.

- Telephone: +81-49-278-1270
- Fax: +81-49-278-1234
- Email: mcsales@njr.co.jp

8. Specification

The Unit is in compliance with the following specifications:

8.1. Power Specification:

No.	Item	Specifications
1.	Input AC Voltage Range Rated Range: Absolute Maximum Rating:	100 to 240 VAC 90 to 264 VAC
2.	Input AC Frequency Range	50/60 Hz
3.	Input AC Apparent Power	200 VA maximum
4.	Output Voltage	+48 VDC
5.	Output Voltage Accuracy	+/- 10 %
6.	Output Current Range	0 to 3.2 A
7.	Maximum Output Power	150 W
8.	Standby Mode Power · No Connect BUC · Non DC Power Output	10 W maximum
8.	Efficiency	80 % typical at 120 VAC, full load
9.	Power Factor	0.98 typical at 120 VAC, full load
10.	Output ON/OFF Control	Rocker Switch on the Front Panel
11.	Input DC Voltage Range at IF/Ref./(DC) Input Port	+24 / +48 VDC (50 mA minimum) Synchronized Output ON/OFF Control
12.	Protection	· Internal Primary Current Fuse · Short Protection
13.	Standard	Compliant with EN55022 EN55024 EN61000-3-2/3 EN60950-1 EN62311

8.2. Reference and IF Specification:

No.	Item	Specifications
1.	Frequency Range	10 MHz and 950 to 1,825 MHz
2.	Input/ Output Impedance <N-type connector> <F-type connector>	50 ohms nominal 75 ohms nominal
3.	Input/ Output VSWR	2 : 1 maximum
4.	Insertion Loss	1.5 dB maximum

8.3. Mechanical and Environmental Specification:

No.	Item	Specifications
1.	Interface AC Input: IF/Ref./(DC) Input: IF/Ref./DC Output:	IEC320-C14 inlet N or F-type female connector N or F-type female connector
2.	Dimension & Housing (W) (D) (H)	290 mm [11.42"] 200 mm [7.87"] 44 mm [1.73"]
3.	Weight	1.6 kg [3.5 lbs]
4.	Cooling	Forced Air by Fan
5.	Temperature Range (ambient) Operating: Storage:	0 to +50 C -30 to +85 C
6.	Humidity Operating: Storage:	30 to 90%Rh non-condensing 10 to 95%Rh
7.	Regulations	EU Directive (CE Marking) EMC (2004/108/EC) LOW VOLTAGE (2006/95/EC)
8.	Comply with RoHS (Restricting the use of Hazardous Substances) directives	