

iDirect 3000 series™ Satellite Router



Installation and Safety Manual

September 25, 2006

CORPORATE HEADQUARTERS

13865 SUNRISE VALLEY DRIVE

HERNDON, VA 20171

703-648-8000

www.idirect.net

Copyright© 2006 iDirect, Inc. All rights reserved. This manual may not be reproduced, in part or in whole without the permission of iDirect, Inc.

The specifications and information regarding the products in this manual are subject to change without notice. All statements, information, and recommendations in this manual are believed to be accurate, but are presented without warranty of any kind, express, or implied. Users must take full responsibility for their application of any products.

Trademarks, brand names and products mentioned in this document are the property of their respective owners. All such references are used strictly in an editorial fashion with no intent to convey any affiliation with the name or the product's rightful owner.

iDirect Technologies™
International Headquarters
13865 Sunrise Valley Drive
Herndon, VA 20171
www.iDirect.net

HQ: 703-648-8000

Toll free from within the US: 888-362-5475

Document Name: IS_3000SR_R_RevB.pdf

Document Part Number: 8100-0024-0001

Contents

1: About This Manual

1.1 Intended Audience	2
1.2 Manual Contents	2
1.3 Document Conventions	2
1.4 Safety Definitions	3
1.5 Getting Help	3

2: Introduction

2.1 General Description	6
2.2 Mounting Tray Option	7

3: Safety Information

3.1 Installation Guidelines	10
3.2 Electrical Safety	11
3.3 Preventing Electrostatic Discharge Damage	13
3.4 Physical and Environmental Considerations	13
3.5 Operational and Maintenance Safety	15
3.6 Safety Guidelines to Observe During Servicing	15
3.6.1 Servicing	15
3.6.2 Conditions Requiring Service	15

4: Specifications

4.1 Mechanical and Environmental Specifications	18
4.2 Power Specifications	19
4.3 RF Specifications	20
4.4 Tools and Supplies	21

4.5 Unpacking iDirect 3000 Satellite Router Equipment	22
4.5.1 Components Normally Included in an Order	23
4.5.2 Additional Components Normally Required	24
4.6 Repacking iDirect 3000 series™ Satellite Routers	24

5: Installation

5.1 Mounting the iDirect 3000 series™ Satellite Router	28
5.1.1 General Guidelines for Mounting Configurations	28
5.1.2 Guidelines for Desktop or Shelf Mounting	28
5.1.3 Guidelines for Rack Mounting	28
5.2 iDirect 3000 series™ Satellite Router Rear Interface Connectors	31
5.3 Preparing the Coax Cables	33
5.3.1 Console Port Cable Specifications and Pinout	37
5.3.2 Ethernet Port Cable Specifications and Pinouts	39
5.4 Connecting AC Power to the IDU	40
5.4.1 Preparing Your PC/Laptop for Connection to the IDU	40
5.4.2 Checking Conditions before Powering Up the System	41
5.4.3 Powering Up the System	41
5.5 Monitoring LED Status Indicators	42
5.5.1 Front Panel Power and Network LED Status Indicators	42
5.5.2 Rear Panel LED Status Definitions	44
5.6 Maintaining the Remote	45
5.6.1 Temperature Control	45
5.6.2 Dust Removal	45

A: Warnings

A.1 Danger/Warning Symbol	47
A.2 Installation Warning	48
A.3 Restricted Area Warning	49
A.4 Service Personnel Warning	50
A.5 Qualified Personnel Warning	51
A.6 Chassis Warning—Rack-Mounting and Servicing	52
A.7 Jewelry Removal Warning	55
A.8 Operating Temperature and Airflow Warning	57
A.9 Lightning Activity Warning	58
A.10 Safety Extra-Low Voltage Port Warning	59

A.11 No On/Off Switch Warning	60
A.12 Disconnect Device Warning	61
A.13 Ground Conductor Warning	62
A.14 Use Copper Conductors Only	63
A.15 Ground Connection Warning	64
A.16 Power Supply Disconnection Warning	64
A.17 Power Cabling Warning	66
A.18 AC Power Supply Circuit Warning	67

B: Compliance

B.1 FCC Compliance	70
B.2 Part 15 Compliance	70
B.3 Canadian Labeling Requirements	71
B.4 CE Compliance (European Union)	71
B.5 Safety	72
B.6 RoHS and WEEE Compliance	72
B.6.1 Compliance with RoHS Directive (2002/95/EC)	72
B.6.2 Compliance with WEEE Directive (2002/96/EC)	73
B.7 Declaration of Conformity	74

Figures

Figure 1	Front View of the iDirect 3000 series™ Satellite Router	6
Figure 2	Front View of the iDirect 3000 series™ Satellite Router in a Rack Mount Tray	7
Figure 3	Rear View of the iDirect 3000 series™ Satellite Router in a Rack Mount Tray	7
Figure 4	Installation Tools	21
Figure 5	DB-9 to RJ-45 Adapter and Connector	22
Figure 6	iDirect 3000 series™ Satellite Router with External Power Supply	23
Figure 7	Typical Antenna with BUC and LNB	24
Figure 8	Front View of an iDirect 3000 series™ Satellite Router in a Rack Mount Tray	29
Figure 9	Rear View of an iDirect 3000 series™ Satellite Router in a Rack Mount Tray	30
Figure 10	iDirect 3000 series™ Satellite Router Rear Interface Connectors	31
Figure 11	Recommended Tools for Terminating Coaxial Cable	33
Figure 12	Coax Cable Cutting Technique	34
Figure 13	Cutting Technique for Removing Foil in the Braid	35
Figure 14	Folding the Braid	35
Figure 15	Attaching the RG-11 Connector	36
Figure 16	Crimp Area for F-Type Plugs	36
Figure 17	Proper Center Connector Length and Crimping Technique	37
Figure 18	Holding the RJ-45 Cable Connectors	37
Figure 19	RJ-45 to DB-9 Female DTE Adapter	38
Figure 20	RJ-45 Cable Connectors, Plug and Receptacle	39
Figure 21	iDirect 3000 series™ Satellite Router Product Label	69

Tables

Table 1	Safety Definitions	3
Table 2	General Safety Warnings and Cautions	10
Table 3	External Power Supply Part Numbers	11
Table 4	Electrical Safety Warnings and Cautions	12
Table 5	Mechanical and Environmental Specifications	18
Table 6	Power Specifications	19
Table 7	RF Specifications	20
Table 8	Recommended Tools	21
Table 9	iDirect 3000 series™ Satellite Router Connectors	31
Table 10	Coax Trim Dimensions	34
Table 11	RJ-45 to DB-9 Pinouts	38
Table 12	Ethernet Port Pinouts	40
Table 13	AC Power Safety Warnings and Cautions	41
Table 14	LED Status	42
Table 15	Front Panel LED Indicators	43
Table 16	Rear Panel LED Indicators	45

1: About This Manual

Thank you for purchasing an iDirect 3000 series™ Satellite Router. This manual provides important safety and compliance information, and explains how to install and maintain the 3000 series Satellite Router.

This chapter contains the following sections:

- *Intended Audience* on page 2
- *Manual Contents* on page 2
- *Document Conventions* on page 2
- *Safety Definitions* on page 3
- *Getting Help* on page 3

1.1 Intended Audience

This manual is intended for use by the VSAT (Very Small Aperture Terminal) equipment installer, System Engineer, and Network Operator responsible for maintaining the iDirect Network. Only qualified service personnel should install and operate the 3000 series router solutions. Familiarity with cabling and wiring practices is beneficial.

In this document, the 3000 series routers are often referred to as IDUs (Indoor Units) while radios and LNBs are collectively referred to as ODUs (Outdoor Units).

1.2 Manual Contents

In addition to the information in this chapter, this manual also includes the following:

- [Chapter 2, *Introduction*](#) provides an overview and description of the 3000 series router.
- [Chapter 3, *Safety Information*](#) describes general cautions.
- [Chapter 4, *Specifications*](#) covers the mechanical, environmental and connector interface requirements.
- [Chapter 5, *Installation*](#) details procedures for installing the 3000 series router.

The following appendixes are also provided:

- [Appendix A, *Warnings*](#) describes warnings to be heeded to prevent personal injury or equipment damage.
- [Appendix B, *Compliance*](#) provides compliance information.

1.3 Document Conventions



This manual is crafted with the reader in mind, providing notes, helpful tips and reminders that assist you in the successful and safe operation of iDirect system hardware. Notes also provide suggestions or references to material not contained in this manual.

NOTE: Notes such as this indicate important information that is of interest to you. Make sure you review this information before you proceed.

1.4 Safety Definitions

Table 1 illustrates and defines the symbols that are used throughout this manual to alert you to possible danger or when to use caution.

Table 1 Safety Definitions

Symbol	Warning type	Definition
	WARNING/CAUTION	When you see this alert symbol and the WARNING or CAUTION heading, strictly follow the warning instructions to avoid personal injury, equipment damage, or loss of data.
	DANGER	Electric shock hazard: When you see this symbol and the DANGER or WARNING heading, strictly follow the warning instructions to avoid electric shock injury.

1.5 Getting Help

The iDirect Technical Assistance Center (TAC) is available to help you 24x7x365. iDS Software user's guides, installation procedures, an FAQ page, and other documentation that supports our products are available on the TAC webpage. Please access our TAC webpage at: <http://www.tac.idirect.net>.

If you are unable to find the answers or information that you need, you can contact the TAC at (703) 648-8151.

If you are interested in purchasing iDirect products, please contact iDirect Corporate Sales by telephone or email.

Telephone: 703-648-8000

Email: SALES@iDirect.net

2: Introduction

iDirect is proud to offer the iDirect 3000 series™ Satellite Routers, which increase processing power by at least four times over our legacy release. The 3000 series routers provides a low-maintenance and user-friendly remote environment. This manual explains how to safely install and maintain the 3000 series router, and it includes important safety information.

This chapter contains the following sections:

- [General Description](#) on page 6
- [Mounting Tray Option](#) on page 7

2.1 General Description

iDirect 3000 series™ Satellite Routers are designed for small to medium-sized enterprise customers with basic remote networking needs. Able to deliver broadband access of up to 18 Mbps downstream and 4.2 Mbps upstream, the 3000 series router can support all of your IP applications remotely, including VoIP and basic video.

The iDirect 3100 Narrow Band Satellite Router (model 3100-NB) is an alternative to the standard model 3100, and is designed specifically for the narrow-band market. This router model has restricted information rates. Refer to the latest iDS Features document for more information.

The 3000 series router is 11.5" wide x 9.5" deep and 2.0" high. It weighs 3.75lbs. The front panel of the 3000 series router has five LEDs: TX, RX, NET, STATUS, and POWER. The definitions of these LED indicators are discussed in detail in [Chapter 5, Installation](#).

The rear panel has three LEDs: POWER, BUC POWER, and LNB POWER. The definitions of these LED indicators are discussed in detail in [Chapter 5, Installation](#).

The rear panel also provides six interface connectors, which are also described in [Chapter 5, Installation](#).



Figure 1 Front View of the iDirect 3000 series™ Satellite Router

2.2 Mounting Tray Option

A Rack-Mount Tray (optional) can be purchased for mounting the iDirect 3000 series™ Satellite Router in a 19" rack. The Rack-Mount Tray is 19" wide x 11.75" deep and 3.5" in height (48.5cm x 30cm X 9cm). It weighs 5 lbs.



Figure 2 Front View of the iDirect 3000 series™ Satellite Router in a Rack Mount Tray



Figure 3 Rear View of the iDirect 3000 series™ Satellite Router in a Rack Mount Tray

3: Safety Information

Follow the safety guidelines in this chapter carefully during installation of your iDirect 3000 series™ Satellite Router. These guidelines help to protect the 3000 series router from potential damage and help to ensure your own personal safety. These safety measures have been translated into multiple languages (see [Appendix A, Warnings](#)). Keep this safety information handy where you can easily refer to it.

Read this entire chapter before you attempt to install or use your 3000 series router. Adhere to all warnings listed on the product's warning labels and in the operating instructions. Follow all operating and usage instructions carefully.

NOTE: See [Section 1.4, Safety Definitions](#) for a description of the Warning icons that are used in this manual.

This chapter contains the following sections:

- [Installation Guidelines](#) on page 10
- [Electrical Safety](#) on page 11
- [Preventing Electrostatic Discharge Damage](#) on page 13
- [Physical and Environmental Considerations](#) on page 13
- [Operational and Maintenance Safety](#) on page 15
- [Safety Guidelines to Observe During Servicing](#) on page 15

3.1 Installation Guidelines

When installing the 3000 series router, observe all caution and warning statements. Follow the general warnings and cautions in [Table 2](#) to help ensure your safety and protect the equipment. However, these guidelines may not cover all of the potentially hazardous situations you may encounter during installation.

The installation of the IDU must comply with the national and local electrical codes, as follows:

- In the United States, the National Fire Protection Association (NFPA) 70, United States National Electric Code.
- In Canada, the Canadian Electric Code, Part 1, CC22.1
- In other countries, the International Electromechanical Commission (IEC) Recommendation 364, part 1 through part 7.

Review the safety instructions in this chapter, and the safety warnings and compliances beginning in [Appendix A, Warnings](#) on page 47 of this manual, before installing, configuring, or performing maintenance on the system.

- Always remove or disconnect ALL power connections before installing or removing a chassis.
- Keep the staging area clear and free of dust during and after installation.
- Keep tools, IDU components, and shipping boxes away from walkway area.
- The IDU operates safely when it is used in accordance with its marked electrical ratings and product usage instructions.

Table 2 General Safety Warnings and Cautions





Symbol	Warning type	Definition
	WARNING/CAUTION	Only Trained and qualified personnel should be allowed to install or replace this equipment.
	WARNING/CAUTION	This equipment is to be installed and maintained by service personnel only as defined by AS/NZS 3260 Clause 1.2.14.4 Service Personnel.

Table 2 General Safety Warnings and Cautions

Symbol	Warning type	Definition
	DANGER	Before working on the ODU equipment, unplug the power cord from the AC power source.
	WARNING/CAUTION	Do not remove IDU chassis enclosure. Do not touch internal circuitry when the power cord is connected.
	WARNING/CAUTION	The BUC power requirement must match the proper IDU voltage. The BUC may sustain damage if used with the incorrect power supply.

3.2 Electrical Safety



The IDU is designed to operate with the following +24 VDC power supply. The Ault Incorporated model number is shown on the power supply label. Refer to the iDirect part number from [Table 3](#) when getting assistance from the TAC.

Table 3 External Power Supply Part Numbers

Number	+24 VDC
iDirect Part Number	2100-0004-0005
Ault, Inc. Model Number	PW122RA2400F02
Operating Tech	120-24-3

Follow the warnings and cautions in [Table 4](#) to ensure your safety and protect the equipment from electrical hazards.

Table 4 Electrical Safety Warnings and Cautions

Symbol	Warning type	Definition
	WARNING/CAUTION	The BUC power requirement must match the proper IDU voltage. The BUC may sustain damage if used with the incorrect power supply.
	DANGER	Do not use any power supply other than what is supplied with the IDU.
	DANGER	Do not work on the system, or connect or disconnect cables, during periods of lightning activity.

Follow the following basic guidelines when you are working with any electrical equipment:

- Disconnect all power and external cables before installing or removing the chassis.
- Do not work alone when potentially hazardous conditions exist.
- Never assume that power has been disconnected; always check.
- Do not perform any action that creates a potential hazard to people or makes the equipment unsafe. Never install equipment that appears damaged.
- Carefully examine your work area for possible hazards, such as wet floor, ungrounded power extension cables, and missing safety grounds.

3.3 Preventing Electrostatic Discharge Damage

Electrostatic discharge (ESD) damage, which occurs when electronic cards or components are improperly handled, can result in complete or intermittent failure.

Use the following guidelines for preventing ESD damage:

- Never touch the connector pins.
- Handle the IDU only by the metal enclosure.
- Avoid contact between the connector pins and clothing. ESD voltages on clothing can cause damage.

3.4 Physical and Environmental Considerations

To protect the equipment and to avoid personal injury, observe the physical and environmental considerations below when installing a 3000 series router:

- **Ventilation**

Slots and openings on the chassis provide ventilation and ensure reliable operation of the product. To protect the chassis from overheating, these openings must NOT be blocked or covered at any time. Do not place this product in a built-in installation, such as a bookcase or enclosed rack, unless proper ventilation is provided or the manufacturer instructions have been followed. If there is any dust build up on the vent openings of the 3000 series router chassis, vacuuming is recommended to remove these particulate to ensure proper airflow.

- **AC Polarization**

This product is equipped with a cord plug that will fit into the power outlet only one way. Do not modify the plug by defeating this feature. If the plug does not fit, contact your electrician to replace your outlet or get the proper power cord. To prevent electric shock or impair performance, do not use this plug with an extension cord or outlet unless you can fully insert the blades without blade exposure.

- **Power Sources**

Operate this product only from the type of power source indicated on the bottom of approved power supplies (100 VAC - 240VAC, 50/60Hz). If you are not sure of the type of power supply at your site, consult your teleport operator or local power company.

- **Power Cord Protection**

Route power supply cords so they are not likely to be walked on or pinched by items placed upon or against them; pay particular attention to cords at plugs, convenience receptacles, and at the point where they exit the product.

- **Overloading**
Do not overload wall outlets, extension cords, or integral convenience receptacles as this can result in a risk of fire or electrical shock.
- **Electrical Safety**
For electrical safety, power line operated equipment accessories connected to this unit should bear the UL, NRTL, CE listing mark and should not be modified so as to defeat the safety features. This helps to avoid any potential hazard from electrical shock or fire. If in doubt, contact qualified service personnel.
- **Water and Moisture**
To reduce the risk of fire or electrical shock, do not expose this product to rain or moisture.
- **Lightning**
For added protection, unplug this product from the wall outlet (and disconnect the antenna and cable system) during a lightning storm or when it is left unattended and unused for long periods. Doing so prevents damage to the product from lightning and power-line surges.
- **Heat**
Do not place the IDU near heat sources such as radiators, heat registers, stoves, or other products (including amplifiers) that produce heat.
- **Accessories**
To avoid personal injury or damage to the iDirect 3000 series™ Satellite Router; do not place the chassis on any unstable rack, cart, stand, table, or bracket. Any mounting of the product should follow the manufacturer's instructions.
- **Attachments**
Do not use attachments unless recommended by the manufacturer as they may cause hazards or damage to equipment.
- **Restricted Access**
This unit is intended for installation in restricted access areas. A restricted access area is where access can only be gained by service personnel through the use of a special tool, lock and key or other means of security, and is controlled by the authority responsible for the location.
- **Grounding**
Never defeat the ground conductor or operate the equipment in the absence of a suitably installed ground conductor. Contact the appropriate electrical inspection authority or an electrician if you are uncertain that suitable grounding is available.

3.5 Operational and Maintenance Safety

As you use your iDirect 3000 series™ Satellite Router, observe the following safety guidelines:

- Cables — Never use any other RF cable than what is supplied or recommended by iDirect.
- Cleaning — Do not use liquid cleaners or aerosol cleaners. Use a cloth for wiping up dust or use a vacuum cleaner to remove dust.
- Object and Liquid Entry — Never push objects of any kind into the 3000 series router through any openings as they may “short out” parts that could result in a fire or electric shock. Never spill liquid of any kind on the 3000 series router.

3.6 Safety Guidelines to Observe During Servicing

When your iDirect 3000 series™ Satellite Router requires service, observe the safety guidelines in this section.

3.6.1 Servicing

Do not attempt to service the 3000 series router internal assemblies, as opening and removing covers may expose you to dangerous voltages or other hazards. There are no user serviceable parts inside. Opening the units will void the warranty. Refer all servicing to qualified service personnel.

3.6.2 Conditions Requiring Service

Unplug the 3000 series router from the AC Power outlet and refer servicing to qualified service personnel under the following conditions:

- When the power supply cord or plug is damaged.
- If liquid has been spilled on, or objects have fallen into, the 3000 series router, or it has been exposed to water.
- If the 3000 series router does not operate normally when following the operating instructions. Adjust only those controls that are covered by the operating instructions. Other adjustments may result in damage and will often require extensive work by a qualified technician to restore the 3000 series router to its normal operation.
- If the 3000 series router has been dropped or if the chassis has been damaged.
- When the 3000 series router exhibits a distinct change in performance.

4: Specifications

The specifications in this chapter describe the mechanical, environmental and connector interfaces for the iDirect 3000 series™ Satellite Router.

This chapter contains the following sections:

- *Mechanical and Environmental Specifications* on page 18
- *Power Specifications* on page 19
- *RF Specifications* on page 20
- *Tools and Supplies* on page 21
- *Unpacking iDirect 3000 Satellite Router Equipment* on page 22
- *Repacking iDirect 3000 series™ Satellite Routers* on page 24

4.1 Mechanical and Environmental Specifications

Ensure that the installation site can accommodate the mechanical and environmental specifications of the IDU. [Table 5](#) details the mechanical and environmental specifications for the iDirect 3000 series™ Satellite Router.

Table 5 Mechanical and Environmental Specifications

Category	Description												
Dimensions	2.0 (H) x 11.5 (W) x 9.5 (D) inches												
Weight	3.75 pounds (1.7 Kg)												
Airflow	natural convection cooling												
Ambient Temperature	<p>Operational: 32°F to 113°F (0°C to 45°C) at 10,000 Feet 32°F to 122°F (0°C to 50°C) at Sea Level</p> <p>Storage: -30°F to 176° F (-34°C to 80°C)</p>												
Temperature Gradient	0.5°C/min												
Relative Humidity	<p>Operational: 0 to 90% non-condensing</p> <p>Storage: 5 to 93%</p>												
Altitude	<p>Operating: ≤ 10,000 feet (3048m)</p> <p>Storage: ≤ 30,000 feet (9144m)</p>												
Operational Vibration (10 minutes per axis)	<p>The IDU chassis will remain operational when exposed to 0.21 grms with the following profile:</p> <table border="1" data-bbox="656 1360 1276 1562"> <thead> <tr> <th>Frequency</th> <th>Slope</th> <th>PSD</th> </tr> </thead> <tbody> <tr> <td>5 to 350 Hz</td> <td>0</td> <td>0.0001 g²/Hz</td> </tr> <tr> <td>350 to 500 Hz</td> <td>-6 dB/octave</td> <td></td> </tr> <tr> <td>500 Hz</td> <td>0</td> <td>0.00005 g²/Hz</td> </tr> </tbody> </table>	Frequency	Slope	PSD	5 to 350 Hz	0	0.0001 g ² /Hz	350 to 500 Hz	-6 dB/octave		500 Hz	0	0.00005 g ² /Hz
Frequency	Slope	PSD											
5 to 350 Hz	0	0.0001 g ² /Hz											
350 to 500 Hz	-6 dB/octave												
500 Hz	0	0.00005 g ² /Hz											
Operational Shock	The IDU chassis shall remain operational when exposed to 10g, 10ms half sine on x, y, z axis.												

4.2 Power Specifications

The iDirect 3000 series™ Satellite Router generates minimal heat; typical power consumption is 20W for the IDU. Ensure that the installation site can accommodate the power specifications of the IDU. [Table 6](#) details the power specifications for the iDirect 3000 series™ Satellite Router.

Table 6 Power Specifications

Category	Description
Input Voltage	+24 VDC (from External Power Supply)
Power Supply Model Number	Use only with the following model numbers: <ul style="list-style-type: none"> • Ault Incorporated: PW122RA2400F02; PW122KA2400F02 • Operating Tech: OTE-120-24-3
Input Voltage Range	100 VAC - 240 VAC Single Phase
Frequency	50 Hz - 60 Hz
Current Consumption	≤ 3.0 Amps maximum <ul style="list-style-type: none"> at 90 VAC: 1.25 Amps typical (with 4W BUC and LNB) at 254 VAC: 0.50 Amps typical (with 4W BUC and LNB)
Protection	<ul style="list-style-type: none"> • Internal, primary current fuse, inside power supply • Over current protection • Short protection
Power Factor Correction	Complies with EN61000-3-2 and EN61000-3-3
Efficiency	86% typical
Input Transient Response	0.5 msec for 50% load change typical
AC Input Connector	IEC-320-C14, 3 pins receptacle on External Power Supply
AC Power Cord	18 AWG, country dependent

4.3 RF Specifications

Table 7 details RF specifications for the iDirect 3000 series™ Satellite Router.

Table 7 RF Specifications

Category	Description										
Frequency Range	Transmit: 950-1700 MHz Receive: 950-1700 MHz										
Frequency Tuning Step Size	Transmit: 38 Hz Receive: Sub-Hertz with Demodulator										
RF Power Range	Transmit: -35 dBm to +7 dBm Receive: -65 dBm to +0 dBm composite										
RF Power Adjustability	Transmit: 0.5 dB Nominal Step Size Receive: Under AGC for all valid Rx input power range										
Typical Transmit and Receive											
Phase Noise (dBc/Hz) at:	<table border="1"> <thead> <tr> <th>Frequency</th> <th>Phase Noise</th> </tr> </thead> <tbody> <tr> <td>1 KHz</td> <td>-83</td> </tr> <tr> <td>10 KHz</td> <td>-83</td> </tr> <tr> <td>100 KHz</td> <td>-96</td> </tr> <tr> <td>1 MHz</td> <td>-112</td> </tr> </tbody> </table>	Frequency	Phase Noise	1 KHz	-83	10 KHz	-83	100 KHz	-96	1 MHz	-112
Frequency	Phase Noise										
1 KHz	-83										
10 KHz	-83										
100 KHz	-96										
1 MHz	-112										
Typical Phase Jitter at 14 KHz to 1 MHz:	≤ 1.8° rms										
Transmit Carrier Suppression	≥ 30 dBc										
Discrete Spurs, harmonics and non-harmonics	≥ 50 dBc, with output ≥ -15 dBm										
Modulator Spectral Shaping	Intelsat: IESS-309										
Transmitter On/Off Ratio	≥ 50 dBc, with output power ≥ -15 dBm										

4.4 Tools and Supplies

Table 8 specifies recommended tools and supplies for a typical IDU installation (see Figure 4 and Figure 5).

Table 8 Recommended Tools

Quantity	Tool
1	Number 2 Phillips screwdriver (for rack mounting)
1	F-Connector Crimping Tool
1	RG-6 Coax Stripper
1	Coax / Wire Cutter
1	DB-9 to RJ-45 Adapter
1	Straight LAN Cable



Figure 4 Installation Tools

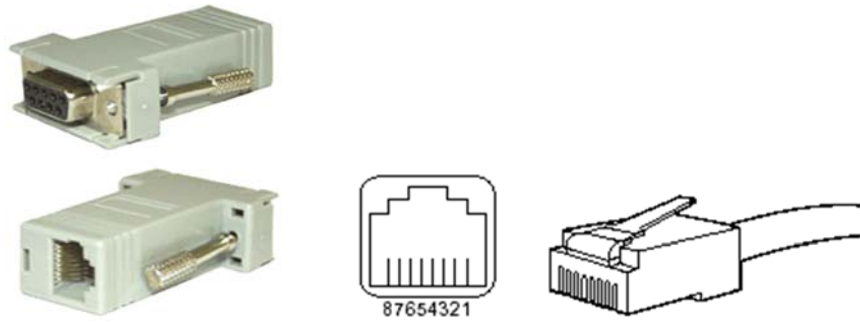

Figure 5 DB-9 to RJ-45 Adapter and Connector

You may need additional tools and equipment to install related equipment and cables. You may also require test equipment to check signal, power levels, and communication links. See [Section 5.3.1, Console Port Cable Specifications and Pinout](#) for cable specifications and RJ-45 pinouts.

4.5 Unpacking iDirect 3000 Satellite Router Equipment

The 3000 series router may be shipped in one or more shipping containers, depending on the type of bundle purchased. Once you have received all of the boxes, perform the following tasks:

- Ensure the boxes are facing upward. (Refer to the box orientation arrows on the shipping container.)
- Inspect all shipping containers. If any damage or other signs of mishandling are evident, inform the carrier and either iDirect or the reseller.
- Remove the tape and any exterior covering from the box lid.

NOTE: Save the iDirect 3000 series™ Satellite Router shipping boxes after you have unpacked the system. You will need these boxes if you want to move or ship the system in the future.

Remove items from the box only as needed. Verify that you have received all of the proper 3000 series router components and accessory items listed in your order, including the optional equipment you ordered.

4.5.1 Components Normally Included in an Order

Prior to installation, ensure that you have received all of the necessary components for a complete VSAT installation (see [Figure 6](#) for an example). If any items are missing or damaged, please contact your Network Operator/Distributor for replacement.



Figure 6 iDirect 3000 series™ Satellite Router with External Power Supply

A typical installation includes:

- An iDirect 3000 series™ Satellite Router with an external power supply
- An AC power cord appropriate for the country of installation
- An antenna ranging in size from 0.96m, 1.2m, 1.8m, or 2.4m for Ku-band; and 1.8m, 2.4m, and 3.8m for C-band
- An appropriate feed assembly for the antenna (OMT)
- A straight through Ethernet LAN cable
- A Block Up Converter (BUC); 1W, 2W or 4W for Ku band and 2W or 5W for C-band
- Optional Ku-Band Power Booster: 8W or 16W
- Optional C-Band Power Booster: 10W or 20W
- Low Noise Block converter (LNB)

4.5.2 Additional Components Normally Required

- An iDirect Specified L-Band cable – Consists of a RG-6 or RG-11 dual-coax cable and connectors (to connect the IDU and ODU), plus type F connectors and sealant tape. (See [Chapter 5, Installation.](#))
- Non-Pen (Non-Penetrating) Roof Mount
- Ballast (anchor weight)



Figure 7 Typical Antenna with BUC and LNB

NOTE: For instructions on installing your antenna, refer to its manufacturer's Installation Guide.

4.6 Repacking iDirect 3000 series™ Satellite Routers

If your system is damaged, or if you need to move the chassis to another location, you need to repack it in the original shipping boxes.

To repack your system:

- 1 Remove all cabling connected to the IDU and ODU.
- 2 Place the IDU or ODU inside the original foam cutout in the shipping box.
- 3 Properly seal the box with packing tape.

For warranty service, obtain a Return Material Authorization (RMA) number from your reseller or iDirect prior to shipping. If you are a direct customer of iDirect, you may contact the iDirect TAC directly to obtain an RMA number and shipping instructions. Follow the shipping instructions, complete the RMA form, and attach the form to the outside of the shipping box. The external Power Supply must be included when returning the IDU.

5: Installation

This chapter describes the guidelines and procedures for installing the iDirect 3000 series™ Satellite Router (IDU) at your VSAT location. This chapter contains the following sections:

- [Mounting the iDirect 3000 series™ Satellite Router](#) on page 28
- [iDirect 3000 series™ Satellite Router Rear Interface Connectors](#) on page 31
- [Preparing the Coax Cables](#) on page 33
- [Connecting AC Power to the IDU](#) on page 41
- [Monitoring LED Status Indicators](#) on page 43
- [Maintaining the Remote](#) on page 46

NOTE: Thoroughly review all the information in [Chapter 3, Safety Information](#), before attempting any of the procedures in the chapter.

5.1 Mounting the iDirect 3000 series™ Satellite Router

The IDU can be mounted on a desktop, shelf, or in a rack using the optional Rack-Mount Tray. This section provides details on how to accomplish the installation.

NOTE: The 3000 series router is designed for indoor use only.

5.1.1 General Guidelines for Mounting Configurations

When installing the IDU, follow these guidelines:

- When selecting the site, consider accessibility, availability of power, signal, network cable connections, and the possibility of future expansion.
- Plan for access to both the front and rear of the IDU chassis.
- Ensure that the room where the IDU operates has adequate ventilation. Ambient air temperature may not cool the IDU chassis to acceptable operating temperatures without adequate ventilation. The ambient temperatures and other environmental specifications are listed in [Chapter 4, Specifications](#).
- Select a suitable IDU installation location away from any area that tends to collect dust.
- Do not install the IDU chassis on the floor.

5.1.2 Guidelines for Desktop or Shelf Mounting

If the IDU chassis is mounted in an enclosed shelf, ensure that the shelf has adequate ventilation. An enclosed shelf should have openings on the sides and top to provide air circulation. Additional fans/blowers may be required if the ambient air in the enclosed shelf exceeds 40°C.

5.1.3 Guidelines for Rack Mounting

If you are installing the 3000 series router in a 19-inch rack, you must use the Rack Mounting Tray Kit (sold separately). The IDU Rack Mount Tray requires a minimum of two rack units (3.5 inches or 8.9 cm) of vertical rack spaces. Be sure to measure the proposed rack location before mounting the chassis.

If you install the IDU in an enclosed rack, ensure that the rack has adequate ventilation. An enclosed rack should have louvered sides and top, with fans, to provide ventilation.



To prevent bodily injury when mounting or servicing the IDU chassis in a rack, you must take special precautions to ensure that the rack remains mechanically stable. iDirect recommends that the equipment rack be firmly secured to the foundation/floor and secured to the adjacent rack.

To mount the 3000 series router in a 19-inch rack:

- 1 Position the front panel of the IDU chassis into the front rectangular opening of the Rack-Mount Tray.



Figure 8 Front View of an iDirect 3000 series™ Satellite Router in a Rack Mount Tray

- 2 Carefully slide the IDU into position on the tray between the side of the tray and the L-shaped brackets.
- 3 Remove the four pan-head screws from the Rack-Mount Tray kit.
- 4 Using a number 2 Phillips head screwdriver, insert the screws through the side of the Rack-Mount Tray and the L-shaped brackets, and tighten them into the empty screw-holes of the IDU case.



Figure 9 Rear View of an iDirect 3000 series™ Satellite Router in a Rack Mount Tray

- 5 Place the External Power Supply on the Rack-Mount Tray. Be sure the IEC-320-C14 AC inlet of the External Power Supply faces the rear of the Rack-Mount Tray.
- 6 Connect the DC output cord of the External Power Supply to the IDU. The excess DC cord can be coiled up and tucked between the External Power Supply and the IDU. Use the supplied 17-inch wire ties to secure the External Power Supply to the tray.
- 7 Mount the Rack Mount Tray into the 19-inch rack.

5.2 iDirect 3000 series™ Satellite Router Rear Interface Connectors

This section describes and illustrates the rear panel connectors. The IDU has six interface connectors as shown in [Figure 10](#). See [Table 9](#) for a description of supported connectors.



Figure 10 iDirect 3000 series™ Satellite Router Rear Interface Connectors



The 3000 series router does NOT support +48 VDC external power supplies. Do not connect any source other than the external +24 VDC power supply provided with the unit. Doing so damages the unit.

Table 9 iDirect 3000 series™ Satellite Router Connectors

Label	Connector Type	Interface and Purpose
+24/+48 5A/2.5A	Kycon KPJ-4S-S	DC input from External Power Supply (Note: The 3000 series router is only available in +24V. Some older versions may have the +48 VDC label. You cannot use a +48 VDC power supply. Doing so damages the IDU).
TX Out	75 ohm, F-Type Female	L-band Transmit signal to Block UpConverter (BUC) capable of 10 MHz Reference and 24 VDC power to BUC.
RX Out	75 ohm, F-Type with DC Blocked Termination Female	Monitor of the actual receive signal from LNB Output, -10 dB nominal composite, buffered.
RX In	75 ohm, F-Type Female	L-band receive signal, capable of 10 MHz Reference and DC power to LNB 75 ohm, F-Connector female
CONSOLE	RJ-45	RS-232, servicing serial connection console to PC or laptop
LAN A	RJ-45	Category-5 STP or UTP cable, 10/100 Base-T Ethernet LAN port connects the 3000 series router to the customer's LAN Hub/switch.

Use high quality coaxial cable to connect the iDirect 3000 series™ Satellite Router to the ODU equipment. iDirect recommends that you use a solid copper center conductor, quad shield, coaxial cable with a minimum of 60% + 40% braid and double foil shield to connect the IDU to the ODU equipment, such as:

- RG-6 – 0.04 inch (1 mm), solid bare copper center conductor (CommScope 5782)
- RG-11 – 0.064 inch (1.6mm), solid bare copper center conductor (5902)

The center conductor must be straight and extend 1/8 inch (3.2 mm) beyond the end of the F-connector, and the connector should be securely crimped to the cable.

NOTE: iDirect does not recommend using RG-59 with solid bare copper center conductor unless the IFL length is less than 120 feet (37 m). If lower RF insertion loss is required due to the distant between the IDU chassis and the ODU equipment, then RG-11 or other 75-ohm types of coax can be used.

If you use different types of coaxial cable other than the recommended quad shield RG-6 or RG-11, the following problems can occur:

- Co-channel Interference - If signals at the same frequency are carried on long, parallel runs of coaxial cable (for example, in cable trays, or riser) interference can occur between the signals. Higher quality cable helps to prevent this with better shielding. Co-channel interference causes degradation in higher packet rate loss.
- Damage to the 3000 series router connectors - The chassis connectors are designed for RG-6 or RG-11 cable and connectors. Larger cables can damage the connectors.
- Good return loss - High quality cable and correct connectors help ensure an optimal return loss of 10 dB or more.
- Excessive DC Resistance - Will result in excessive voltage drop across the IFL cable. Hence, the voltage at the BUC may be too low to operate properly.

5.3 Preparing the Coax Cables

[Figure 11](#) shows all of the recommended tools.



Paladin Tools: LC-CST-CATV-"F" 1257



Coax Cutter: Benner-Nawman UP-B76



Cable Prep: RG-6 HCT-775 Hex Crimper, Size 0.384 inch
RG-11 HCT-116 Hex Crimper, Size 0.472 inch

Figure 11 Recommended Tools for Terminating Coaxial Cable

Before you can connect the cables, you must install connectors on each end.

To terminate the cables with F-Type connectors:

- 1 Cut off each end of the coax cable squarely, using the proper cable cutter.



Figure 12 Coax Cable Cutting Technique



Wear protective eye wear while cutting cables and terminating connectors. Ensure that the center conductor is straight and cylindrical without any burrs. Failure to do so can damage the IDU, BUC, and/or LNB input connector.

- 2 Remove the jacket material and foam insulation according to the length defined under **Length A** in [Table 10](#). For RG-6, use a two-step Coax Stripper such as the LC-CST 1257 from Paladin Tools.

Table 10 Coax Trim Dimensions

	Length A (inch (mm))	Length B (inch (mm))	Length C (inch (mm))
RG-6	5/8 (15.9)	1/4 (6.4)	3/8 (9.5)
RG-11	13/32 (10.3)	3/32 (2.4)	13/32 (10.3)

- 3 Remove any foil in the braid.



Figure 13 Cutting Technique for Removing Foil in the Braid

- 4 Fold the braid back over the jacket and trim the braid to the length as defined under Length C in [Table 10](#).

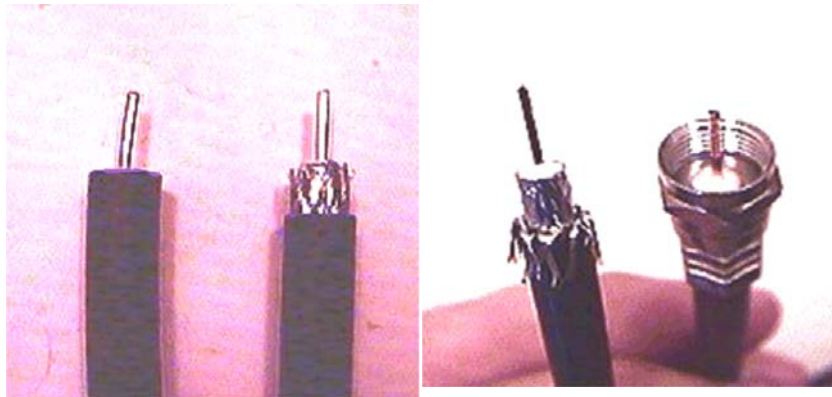

Figure 14 Folding the Braid

- 5 Flare the inner, outer braids and the outer foil shield only. Do not flare the inner foil shield (last foil around dielectric).
- 6 (If using a coax stripper, skip this step.) Being careful not to cut into the copper of the center conductor, remove the foil and cut the dielectric to the length shown under Length B in [Table 10](#). Remove any dielectric residue.
- 7 If the conductive foil is burred, then smooth out the burr so that the edge (area where the dielectric material was removed) is smooth and provides a lead-in for the connector mandrel.
- 8 Install connector mandrel over foil and underneath the braid.

NOTE: The white color inner dielectric insulation should be flush with the inner rear surface of the connector. Refer to the picture on the right in [Figure 15](#) for an RG-11 termination.

- 9 Since RG-11 connector has a built-in center pin, ensure that the coax center pin makes contact to the internal seizing pin of the connector. Refer to [Figure 15](#).

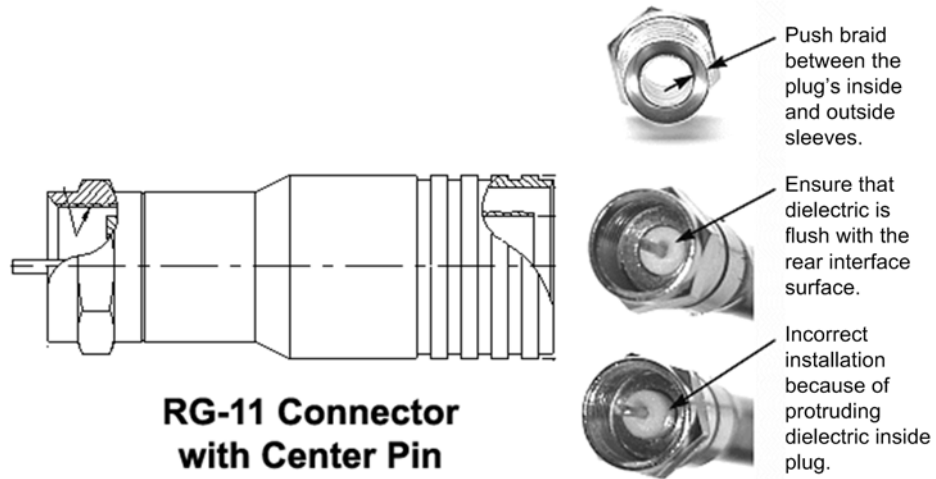

Figure 15 Attaching the RG-11 Connector

- 10 Crimp the connector with the proper crimp tool such as CablePrep HCT-775 for RG-6 or HCT-116 for RG-11.

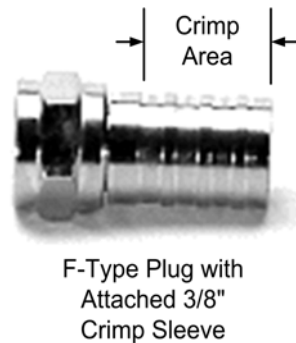

Figure 16 Crimp Area for F-Type Plugs

- 11 Inspect and ensure that the copper center conductor only protrudes 1/8 inch (3.2 mm) nominally beyond the rim of the F-connector. Trim if necessary.

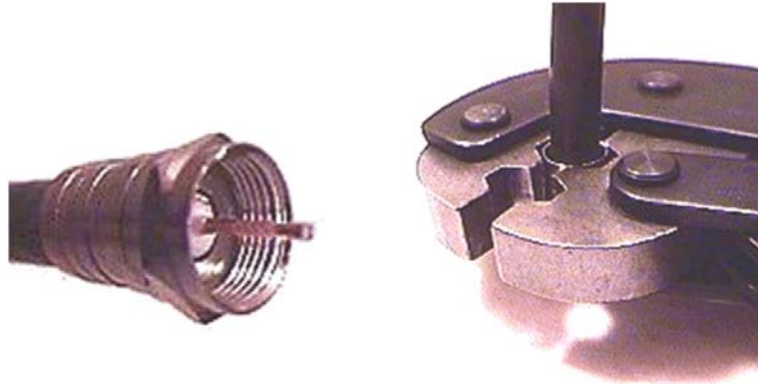

Figure 17 Proper Center Connector Length and Crimping Technique

5.3.1 Console Port Cable Specifications and Pinout

Use the RJ-45-to-RJ-45 straight cable and RJ-45 to DB-9 female DTE adapter to connect the Universal Line Card Console Port to the PC that is running terminal emulation software. You can identify whether a cable is straight-through or crossover by comparing the two RJ-45 connectors at the ends of the Ethernet cable.

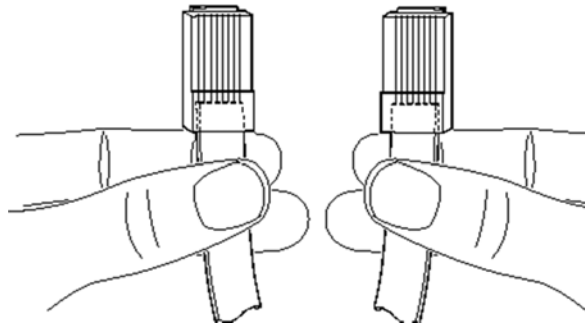

Figure 18 Holding the RJ-45 Cable Connectors

- Straight through – The colored wires are in the same sequence at both ends of the cable.
- Crossover – The first (far left) colored wire at one end of the cable is the third colored wire at the other end of the cable.

Table 11 lists the signal and pinouts for the asynchronous serial Console Port and the RJ-45 to DB-9 female DTE adapter.

Table 11 RJ-45 to DB-9 Pinouts

Console Port (DTE)	RJ-45 Pin	Color Code	RJ-45 to DB-9 Terminal Adapter	Console Device
RTS	1	Blue	8	CTS
DTR	2	Orange	6	DSR
TxD	3	Black	2	RxD
GND	4	Red	NC	GND
GND	5	Green	5	GND
RxD	6	Yellow	3	TxD
DSR	7	Brown	4	DTR
Rx-RF-Power	8	White/Grey	9	--



Figure 19 RJ-45 to DB-9 Female DTE Adapter

NOTE: For use with External GPS and NMEA 0183 protocol standard, use Pins 5 and 6 of RJ-45 or Pins 5 and 3 on DB-9 Terminal Adapter to interface with the serial port of the GPS to obtain various GPS information.

5.3.2 Ethernet Port Cable Specifications and Pinouts

The 10 Base-T/100 Base-T Fast Ethernet ports support IEEE 802.3 and IEEE 802.3u specifications for the 10-Mbps and 100-Mbps transmission over Unshielded Twisted-Pair (UTP) cables. Use Category-3 or Category-5 UTP cable with RJ-45 connectors to attach the 10/100 Base-T Ethernet LAN A port on the iDirect 3000 series™ Satellite Router chassis to the customer provided LAN Hub or switch.

NOTE: iDirect supplies one 7-foot Category 5 UTP cable to connect the 3000 series router to the LAN hub or switch. If additional cables or different lengths are needed, they may be bought commercially.

To determine the type of RJ-45 cable, examine the sequence of the colored wires as follows:

- Straight through – The colored wires are in the same sequence at both ends of the cable.
- Crossover – The first (far left) colored wire at one end of the cable is the third colored wire at the other end of the cable, and the second colored wire at one end of the cable is the sixth colored wire at the end of the cable.

Table 12 lists the pinouts for the Ethernet ports of the IDU chassis.

Table 12 Ethernet Port Pinouts

RJ-45 Pin	Description
1	Tx+
2	Tx-
3	Rx+
6	Rx-

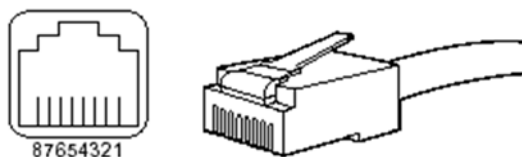





Figure 20 RJ-45 Cable Connectors, Plug and Receptacle

5.4 Connecting AC Power to the IDU

The IDU can be powered directly from the facility AC power source from 100 VAC to 240 VAC. iDirect recommends that the chassis be powered from a low noise, low transient AC power source. [Table 13](#) presents safety warnings and cautions related to AC power.

Table 13 AC Power Safety Warnings and Cautions

Symbol	Warning type	Definition
	WARNING/CAUTION	Improper AC power source rating, excessive noise or transients, or undersized circuit breaker will result in service interruption.
	DANGER	Never disconnect the power to the IDU using the DC output power cord of the external power supply.
	WARNING/CAUTION	If you must remove power from the chassis, you should disconnect power using the AC power cord.

5.4.1 Preparing Your PC/Laptop for Connection to the IDU

See [Section 5.2](#), *iDirect 3000 series™ Satellite Router Rear Interface Connectors* for more information about the interface connectors.

Ensure that your PC/laptop:

- Is loaded with iDirect's iSite software
- Contains a Network Interface Card (NIC) connected with a crossover cable to the 10/100 LAN port of the IDU
- Is running console terminal software, such as HyperTerminal

5.4.2 Checking Conditions before Powering Up the System

Check for the following conditions before you power up the IDU chassis:

- Verify that no RF coax cables are connected to the TX and RX ports on the rear of the chassis.
- Verify that a DB-9 to RJ-45 adapter connects the COM Port of the PC/laptop to the Console port of the IDU (typical terminal settings are COM1, 9600 baud, 8 data bits, no parity, one stop bit, and no flow control).



Do not connect or disconnect the Tx or Rx IFL cable while the IDU is powered; this action may result in damage to the BUC, LNB, and/or IDU.

5.4.3 Powering Up the System

After checking the setup as outlined above, power up the IDU as follows:

- Connect DC output from the power supply to the +24 VDC input of the IDU.
- Connect the AC cord to the external power supply, and then plug the AC power cord into the AC outlet.

Upon boot up, the PWR LED illuminates green, and within several seconds the STATUS LED flashes green as the unit performs a self-diagnostic test. If this test is successful, the STATUS LED illuminates green. If the test fails, the STATUS LED illuminates red.

After the initial hardware diagnostic, the system takes approximately one minute to complete the boot up cycle, during which the STATUS LED flashes green. If the application successfully loads, the STATUS LED illuminates solid green. If the application cannot start due to configuration or other errors, the STATUS LED illuminates solid red (see [Table 14](#)).

Table 14 LED Status

LED Label	LED Color
PWR	Solid Green
NET	Off
STATUS	Solid Green
TX	Off
RX	Solid Yellow

NOTE: The STATUS LED is normally green. A red STATUS LED indicates a malfunction of the IDU.



Always connect or disconnect power to the IDU with the AC power cord at the power supply unit. Never connect or disconnect power to the IDU with the DC cord from the power supply unit while it is being powered on; this action may result in damage the BUC, LNB, and/or IDU.

5.5 Monitoring LED Status Indicators

Once the IDU is powered up with the appropriate Options file, check the LEDs to ensure the IDU is functioning properly.

5.5.1 Front Panel Power and Network LED Status Indicators

For diagnostic purposes, the IDU chassis has five LED indicators located on the front panel.

- The PWR LED indicates whether the IDU is powered on or off.
- The STATUS LED indicates the IDU overall status.
- The NET LED indicates the IDU network acquisition status.
- The Tx LED indicates the IDU transmitter status.
- The Rx LED indicates the IDU receiver status.

The colors of the LEDs indicate the state of the IDU as defined in [Table 15](#).

Table 15 Front Panel LED Indicators

LED Label	LED Color	Indicated Unit Status
PWR	OFF	Indicates that the IDU is powered off or there is a Power Supply problem.
	GREEN	Indicates that the IDU is powered on. The bootloader has started.
NET	GREEN	Indicates that the remotes have been acquired into the network.
	FLASHING GREEN	Indicates that the elements are in network acquisition.
	YELLOW	Indicates that the downstream SCPC is locked.
	FLASHING YELLOW	Indicates that the downstream SCPC is not locked.
STATUS	GREEN	IDU is functioning properly. The DRAM test is successful.
	FLASHING GREEN	Indicates that the unit is booting. The DRAM test is in progress.
	RED	Indicates a serious fault or failure in software, hardware, or configuration. May indicate that the DRAM test failed.
TX	GREEN	Indicates that the IDU transmitter is enabled.
	YELLOW	Indicates that the IDU transmitter is disabled.
RX	GREEN	Indicates that the receiver is successfully locked to the downstream.
	YELLOW	Indicates that the IDU is not locked to the downstream carrier.

5.5.2 Rear Panel LED Status Definitions

There are three LEDs on the rear of the IDU that indicate whether certain components of the IDU are powered on or off (see [Table 16](#)).

Table 16 Rear Panel LED Indicators

LED Label	LED Color	Indicated Unit Status
INPUT PWR	OFF	Indicates that the IDU does not have power.
	GREEN	Indicates that the IDU has power.
BUC PWR	OFF	Indicates that the BUC power is not being supplied.
	GREEN	Indicates that the BUC power (+24 VDC) is being supplied.
	RED	Indicates a BUC problem or an IFL disturbance.
LNB PWR	OFF	Indicates that the LNB power is not being supplied.
	GREEN	Indicates that the LNB power (+19 VDC nominal) is being supplied.
	RED	Indicates an LNB problem or an IFL disturbance.

5.6 Maintaining the Remote

The IDU requires basic maintenance to keep it running efficiently and to prolong its life. However, the only maintenance you need to perform on the unit, without explicit directions from iDirect Technologies, is to maintain the temperature of the IDU and keep its external areas free from dust or dirt.

NOTE: There are no user-serviceable parts within the iDirect 3000 series™ Satellite Router. Do not attempt to repair/replace a malfunctioning or defective component/module. Doing so may void the warranty.

5.6.1 Temperature Control

The IDU has a built-in temperature sensor. The temperature sensor measures the actual circuit board temperature. If the board temperature exceeds a defined threshold, the IDU alerts the NMS about the high temperature condition. See [Chapter 4, Specifications](#), for the proper temperature range.

Various conditions can cause the IDU chassis to have an elevated internal temperature, such as:

- Objects blocking the enclosure vents
- Dust accumulated on the enclosure or the vents
- Ambient temperature elevated beyond the specified limits

5.6.2 Dust Removal

A dusty environment requires frequent maintenance. With the unit powered down, use a slightly damp cloth with the excess moisture wrung out (not a saturated, dripping-wet cloth) to wipe away the dust that collects on the outside of the enclosure.

Vacuum the dust off the enclosure vents. Vacuum the circuit board through the enclosure vents, if possible.

A: Warnings

This appendix repeats the warnings contained in this manual in multiple languages.

A.1 Danger/Warning Symbol



DANGER: This symbol means danger! You are in a situation that could cause bodily injury. Before you work on any equipment, be aware of the hazards involved with electrical circuitry and be familiar with standard practices for preventing accidents.

Waarschuwing	Dit waarschuwingssymbool betekent gevaar. U verkeert in een situatie die lichamelijk letsel kan veroorzaken. Voordat u aan enige apparatuur gaat werken, dient u zich bewust te zijn van de bij elektrische schakelingen betrokken risico's en dient u op de hoogte te zijn van standaard maatregelen om ongelukken te voorkomen.
Varoitus	Tämä varoitusmerkki merkitsee vaaraa. Olet tilanteessa, joka voi johtaa ruumiinvammaan. Ennen kuin työskentelet minkään laitteiston parissa, ota selvää sähkökytkentöihin liittyvistä vaaroista ja tavanomaisista onnettomuuksien ehkäisykeinoista.
Attention	Ce symbole d'avertissement indique un danger. Vous vous trouvez dans une situation pouvant causer des blessures ou des dommages corporels. Avant de travailler sur un équipement, soyez conscient des dangers posés par les circuits électriques et familiarisez-vous avec les procédures couramment utilisées pour éviter les accidents.
Warnung	Dieses Warnsymbol bedeutet Gefahr. Sie befinden sich in einer Situation, die zu einer Körperverletzung führen könnte. Bevor Sie mit der Arbeit an irgendeinem Gerät beginnen, seien Sie sich der mit elektrischen Stromkreisen verbundenen Gefahren und der Standardpraktiken zur Vermeidung von Unfällen bewußt.

Avvertenza	Questo simbolo di avvertenza indica un pericolo. La situazione potrebbe causare infortuni alle persone. Prima di lavorare su qualsiasi apparecchiatura, occorre conoscere i pericoli relativi ai circuiti elettrici ed essere al corrente delle pratiche standard per la prevenzione di incidenti.
Advarsel	Dette varselsymbolet betyr fare. Du befinner deg i en situasjon som kan føre til personskade. Før du utfører arbeid på utstyr, må du være oppmerksom på de faremomentene som elektriske kretser innebærer, samt gjøre deg kjent med vanlig praksis når det gjelder å unngå ulykker.
Aviso	Este símbolo de aviso indica perigo. Encontra-se numa situação que lhe poderá causar danos físicos. Antes de começar a trabalhar com qualquer equipamento, familiarize-se com os perigos relacionados com circuitos eléctricos, e com quaisquer práticas comuns que possam prevenir possíveis acidentes.
¡Advertencia!	Este símbolo de aviso significa peligro. Existe riesgo para su integridad física. Antes de manipular cualquier equipo, considerar los riesgos que entraña la corriente eléctrica y familiarizarse con los procedimientos estándar de prevención de accidentes.
Varning!	Denna varningssymbol signalerar fara. Du befinner dig i en situation som kan leda till personskada. Innan du utför arbete på någon utrustning måste du vara medveten om farorna med elkretsar och känna till vanligt förfarande för att förebygga skador.

A.2 Installation Warning



WARNING: Read the installation instructions before you connect the system to the power source.

Waarschuwing	Raadpleeg de installatie-aanwijzingen voordat u het systeem met de voeding verbindt.
Varoitus	Lue asennusohjeet ennen järjestelmän yhdistämistä virtalähteeseen.
Attention	Avant de brancher le système sur la source d'alimentation, consulter les directives d'installation.
Warnung	Lesen Sie die Installationsanweisungen, bevor Sie das System an die Stromquelle anschließen.
Avvertenza	Consultare le istruzioni di installazione prima di collegare il sistema all'alimentatore.

Advarsel	Les installasjonsinstruksjonene før systemet kobles til strømkilden.
Aviso	Leia as instruções de instalação antes de ligar o sistema à sua fonte de energia.
¡Advertencia!	Ver las instrucciones de instalación antes de conectar el sistema a la red de alimentación.
Varning!	Läs installationsanvisningarna innan du kopplar systemet till dess strömförsörjningsenhet.

A.3 Restricted Area Warning



WARNING: This unit is intended for installation in restricted access areas. A restricted access area is where access can only be gained by service personnel through the use of a special tool, lock and key or other means of security, and is controlled by the authority responsible for the location.

Waarschuwing	Dit toestel is bedoeld voor installatie op plaatsen met beperkte toegang. Een plaats met beperkte toegang is een plaats waar toegang slechts door servicepersoneel verkregen kan worden door middel van een speciaal instrument, een slot en sleutel, of een ander veiligheidsmiddel, en welke beheerd wordt door de overheidsinstantie die verantwoordelijk is voor de locatie.
Varoitus	Tämä laite on tarkoitettu asennettavaksi paikkaan, johon pääsy on rajoitettua. Paikka, johon pääsy on rajoitettua, tarkoittaa paikkaa, johon vain huoltohenkilöstö pääsee jonkin erikoistyökalun, lukkoon sopivan avaimen tai jonkin muun turvalaitteen avulla ja joka on paikasta vastuussa olevien toimivaltaisten henkilöiden valvoma.
Attention	Cet appareil est à installer dans des zones d'accès réservé. Ces dernières sont des zones auxquelles seul le personnel de service peut accéder en utilisant un outil spécial, un mécanisme de verrouillage et une clé, ou tout autre moyen de sécurité. L'accès aux zones de sécurité est sous le contrôle de l'autorité responsable de l'emplacement.
Warnung	Diese Einheit ist zur Installation in Bereichen mit beschränktem Zutritt vorgesehen. Ein Bereich mit beschränktem Zutritt ist ein Bereich, zu dem nur Wartungspersonal mit einem Spezialwerkzeugs, Schloß und Schlüssel oder anderer Sicherheitsvorkehrungen Zugang hat, und der von dem für die Anlage zuständigen Gremium kontrolliert wird.

Avvertenza	Questa unità deve essere installata in un'area ad accesso limitato. Un'area ad accesso limitato è un'area accessibile solo a personale di assistenza tramite un'attrezzo speciale, lucchetto, o altri dispositivi di sicurezza, ed è controllata dall'autorità responsabile della zona.
Advarsel	Denne enheten er laget for installasjon i områder med begrenset adgang. Et område med begrenset adgang gir kun adgang til servicepersonale som bruker et spesielt verktøy, lås og nøkkel, eller en annen sikkerhetsanordning, og det kontrolleres av den autoriteten som er ansvarlig for området.
Aviso	Esta unidade foi concebida para instalação em áreas de acesso restrito. Uma área de acesso restrito é uma área à qual apenas tem acesso o pessoal de serviço autorizado, que possua uma ferramenta, chave e fechadura especial, ou qualquer outra forma de segurança. Esta área é controlada pela autoridade responsável pelo local.
¡Advertencia!	Esta unidad ha sido diseñada para instalarse en áreas de acceso restringido. Área de acceso restringido significa un área a la que solamente tiene acceso el personal de servicio mediante la utilización de una herramienta especial, cerradura con llave, o algún otro medio de seguridad, y que está bajo el control de la autoridad responsable del local.
Varning!	Denna enhet är avsedd för installation i områden med begränsat tillträde. Ett område med begränsat tillträde får endast tillträdas av servicepersonal med ett speciellt verktyg, lås och nyckel, eller annan säkerhetsanordning, och kontrolleras av den auktoritet som ansvarar för området.

A.4 Service Personnel Warning



WARNING: This equipment is to be installed and maintained by service personnel only as defined by AS/NZS 3260 Clause 1.2.14.3 Service Personnel.

Waarschuwing	Deze apparatuur mag slechts geïnstalleerd en onderhouden worden door servicepersoneel conform de definitie van AS/NZS 3260 Clause 1.2.14.3 Service Personnel.
Varoitus	Tämän laitteen saa asentaa tai huoltaa ainoastaan Australiassa ja Uudessa Seelannissa sovellettavan AS/NZS 3260 -standardin kohdan 1.2.14.3 Service Personnel määrittelemä huoltohenkilöstö.

Attention	Cet équipement ne doit être installé et entretenu que par du personnel d'entretien comme défini par la réglementation AS/NZS 3260 Clause 1.2.14.3 Service Personnel.
Warnung	Dieses Gerät darf nur von Wartungspersonal gemäß AS/NZS-Definition 3260, Paragraph 1.2.14.3, "Service Personnel", installiert und gewartet werden.
Avvertenza	Questo apparecchio deve essere installato e mantenuto in efficienza esclusivamente da personale tecnico che soddisfi i requisiti specificati nella sezione 1.2.14.3 sul "Service Personnel" contenuta nelle norme AS/NZS 3260.
Advarsel	Installasjon og vedlikehold av dette utstyret skal kun foretas av vedlikeholdspersonell som definert i AS/NZS 3260, klausul 1.2.14.3 Service Personnel.
Aviso	Este equipamento deverá ser instalado e reparado apenas por pessoal de manutenção qualificado, conforme estipulado em AS/NZS 3260 Cláusula 1.2.14.3 Service Personnel.
¡Advertencia!	Este equipo se debe instalar y mantener solamente por personal de servicio, según definido por AS/NZS 3260 Cláusula 1.2.14.3 Service Personnel.
Varning!	Installation och underhåll av denna utrustning får endast utföras av servicepersonal enligt definition i AS/NZS 3260 klausul 1.2.14.3 Service Personnel.

A.5 Qualified Personnel Warning



WARNING: Only trained and qualified personnel should be allowed to install or replace this equipment.

Waarschuwing	Installatie en reparaties mogen uitsluitend door getraind en bevoegd personeel uitgevoerd worden.
Varoitus	Ainoastaan koulutettu ja pätevä henkilökunta saa asentaa tai vaihtaa tämän laitteen.
Attention	Cet équipement ne doit être installé et entretenu que par du personnel d'entretien comme défini par la réglementation AS/NZS 3260 Clause 1.2.14.3 Service Personnel.
Avertissement	Tout installation ou remplacement de l'appareil doit être réalisé par du personnel qualifié et compétent.

Achtung	Gerät nur von geschultem, qualifiziertem Personal installieren oder auswechseln lassen.
Avvertenza	Solo personale addestrato e qualificato deve essere autorizzato ad installare o sostituire questo apparecchio.
Advarsel	Kun kvalifisert personell med riktig opplæring bør montere eller bytte ut dette utstyret.
Aviso	Este equipamento deverá ser instalado ou substituído apenas por pessoal devidamente treinado e qualificado.
¡Atención!	Estos equipos deben ser instalados y reemplazados exclusivamente por personal técnico adecuadamente preparado y capacitado.
Varning!	Denna utrustning ska endast installeras och bytas ut av utbildad och kvalificerad personal.

A.6 Chassis Warning—Rack-Mounting and Servicing



WARNING: To prevent bodily injury when mounting or servicing this unit in a rack, you must take special precautions to ensure that the system remains stable. The following guidelines are provided to ensure your safety:

- This unit should be mounted at the bottom of the rack if it is the only unit in the rack.
- When mounting this unit in a partially filled rack, load the rack from the bottom to the top with the heaviest component at the bottom of the rack.
- If the rack is provided with stabilizing devices, install the stabilizers before mounting or servicing the unit in the rack.

Waarschuwing	Om lichamelijk letsel te voorkomen wanneer u dit toestel in een rek monteert of het daar een servicebeurt geeft, moet u speciale voorzorgsmaatregelen nemen om ervoor te zorgen dat het toestel stabiel blijft. De onderstaande richtlijnen worden verstrekt om uw veiligheid te verzekeren: <ul style="list-style-type: none">• Dit toestel dient onderaan in het rek gemonteerd te worden als het toestel het enige in het rek is.• Wanneer u dit toestel in een gedeeltelijk gevuld rek monteert, dient u het rek van onderen naar boven te laden met het zwaarste onderdeel onderaan in het rek.• Als het rek voorzien is van stabiliseringshulpmiddelen, dient u de stabilisatoren te monteren voordat u het toestel in het rek monteert of het daar een servicebeurt geeft.
--------------	---

Varoitus	<p>Kun laite asetetaan telineeseen tai huolletaan sen ollessa telineessä, on noudatettava erityisiä varotoimia järjestelmän vakavuuden säilyttämiseksi, jotta vältetään loukkaantumiselta. Noudata seuraavia turvallisuusohjeita:</p> <ul style="list-style-type: none">• Jos telineessä ei ole muita laitteita, aseta laite telineen alaosaan.• Jos laite asetetaan osaksi täytettyyn telineeseen, aloita kuormittaminen sen alaosaan kaikkein raskaimmalla esineellä ja siirry sitten sen yläosaan.• Jos telinettä varten on vakaimet, asenna ne ennen laitteen asettamista telineeseen tai sen huoltamista siinä.
Attention	<p>Pour éviter toute blessure corporelle pendant les opérations de montage ou de réparation de cette unité en casier, il convient de prendre des précautions spéciales afin de maintenir la stabilité du système. Les directives ci-dessous sont destinées à assurer la protection du personnel :</p> <ul style="list-style-type: none">• Si cette unité constitue la seule unité montée en casier, elle doit être placée dans le bas.• Si cette unité est montée dans un casier partiellement rempli, charger le casier de bas en haut en plaçant l'élément le plus lourd dans le bas.• Si le casier est équipé de dispositifs stabilisateurs, installer les stabilisateurs avant de monter ou de réparer l'unité en casier.
Warnung	<p>Zur Vermeidung von Körperverletzung beim Anbringen oder Warten dieser Einheit in einem Gestell müssen Sie besondere Vorkehrungen treffen, um sicherzustellen, daß das System stabil bleibt. Die folgenden Richtlinien sollen zur Gewährleistung Ihrer Sicherheit dienen:</p> <ul style="list-style-type: none">• Wenn diese Einheit die einzige im Gestell ist, sollte sie unten im Gestell angebracht werden.• Bei Anbringung dieser Einheit in einem zum Teil gefüllten Gestell ist das Gestell von unten nach oben zu laden, wobei das schwerste Bauteil unten im Gestell anzubringen ist.• Wird das Gestell mit Stabilisierungszubehör geliefert, sind zuerst die Stabilisatoren zu installieren, bevor Sie die Einheit im Gestell anbringen oder sie warten.

Avvertenza	<p>Per evitare infortuni fisici durante il montaggio o la manutenzione di questa unità in un supporto, occorre osservare speciali precauzioni per garantire che il sistema rimanga stabile. Le seguenti direttive vengono fornite per garantire la sicurezza personale:</p> <ul style="list-style-type: none">• Questa unità deve venire montata sul fondo del supporto, se si tratta dell'unica unità da montare nel supporto.• Quando questa unità viene montata in un supporto parzialmente pieno, caricare il supporto dal basso all'alto, con il componente più pesante sistemato sul fondo del supporto.• Se il supporto è dotato di dispositivi stabilizzanti, installare tali dispositivi prima di montare o di procedere alla manutenzione dell'unità nel supporto.
Advarsel	<p>Unngå fysiske skader under montering eller reparasjonsarbeid på denne enheten når den befinner seg i et kabinett. Vær nøye med at systemet er stabilt. Følgende retningslinjer er gitt for å verne om sikkerheten:</p> <ul style="list-style-type: none">• Denne enheten bør monteres nederst i kabinettet hvis dette er den eneste enheten i kabinettet.• Ved montering av denne enheten i et kabinett som er delvis fylt, skal kabinettet lastes fra bunnen og opp med den tyngste komponenten nederst i kabinettet.• Hvis kabinettet er utstyrt med stabiliseringsutstyr, skal stabilisatorene installeres før montering eller utføring av reparasjonsarbeid på enheten i kabinettet.
Aviso	<p>Para se prevenir contra danos corporais ao montar ou reparar esta unidade numa estante, deverá tomar precauções especiais para se certificar de que o sistema possui um suporte estável. As seguintes directrizes ajudá-lo-ão a efectuar o seu trabalho com segurança:</p> <ul style="list-style-type: none">• Esta unidade deverá ser montada na parte inferior da estante, caso seja esta a única unidade a ser montada.• Ao montar esta unidade numa estante parcialmente ocupada, coloque os itens mais pesados na parte inferior da estante, arrumando-os de baixo para cima.• Se a estante possuir um dispositivo de estabilização, instale-o antes de montar ou reparar a unidade.

- ¡Advertencia! Para evitar lesiones durante el montaje de este equipo sobre un bastidor, o posteriormente durante su mantenimiento, se debe poner mucho cuidado en que el sistema quede bien estable. Para garantizar su seguridad, proceda según las siguientes instrucciones:
- Colocar el equipo en la parte inferior del bastidor, cuando sea la única unidad en el mismo.
 - Cuando este equipo se vaya a instalar en un bastidor parcialmente ocupado, comenzar la instalación desde la parte inferior hacia la superior colocando el equipo más pesado en la parte inferior.
 - Si el bastidor dispone de dispositivos estabilizadores, instalar éstos antes de montar o proceder al mantenimiento del equipo instalado en el bastidor.

-
- Varning! För att undvika kroppsskada när du installerar eller utför underhållsarbete på denna enhet på en ställning måste du vidta särskilda försiktighetsåtgärder för att försäkra dig om att systemet står stadigt. Följande riktlinjer ges för att trygga din säkerhet:
- Om denna enhet är den enda enheten på ställningen skall den installeras längst ned på ställningen.
 - Om denna enhet installeras på en delvis fylld ställning skall ställningen fyllas nedifrån och upp, med de tyngsta enheterna längst ned på ställningen.
 - Om ställningen är försedd med stabiliseringsdon skall dessa monteras fast innan enheten installeras eller underhålls på ställningen.
-

A.7 Jewelry Removal Warning



WARNING: Before working on equipment that is connected to power lines, remove jewelry (including rings, necklaces, and watches). Metal objects will heat up when connected to power and ground and can cause serious burns or weld the metal object to the terminals.

-
- Waarschuwing Alvorens aan apparatuur te werken die met elektrische leidingen is verbonden, sieraden (inclusief ringen, kettingen en horloges) verwijderen. Metalen voorwerpen worden warm wanneer ze met stroom en aarde zijn verbonden, en kunnen ernstige brandwonden veroorzaken of het metalen voorwerp aan de aansluitklemmen lassen.
-

Varoitus	Ennen kuin työskentelet voimavirtajohtoihin kytkettyjen laitteiden parissa, ota pois kaikki korut (sormukset, kaulakorut ja kellot mukaan lukien). Metalliesineet kuumenevat, kun ne ovat yhteydessä sähkövirran ja maan kanssa, ja ne voivat aiheuttaa vakavia palovammoja tai hitsata metalliesineet kiinni liitännänapoihin.
Attention	Avant d'accéder à cet équipement connecté aux lignes électriques, ôter tout bijou (anneaux, colliers et montres compris). Lorsqu'ils sont branchés à l'alimentation et reliés à la terre, les objets métalliques chauffent, ce qui peut provoquer des blessures graves ou souder l'objet métallique aux bornes.
Warnung	Vor der Arbeit an Geräten, die an das Netz angeschlossen sind, jeglichen Schmuck (einschließlich Ringe, Ketten und Uhren) abnehmen. Metallgegenstände erhitzen sich, wenn sie an das Netz und die Erde angeschlossen werden, und können schwere Verbrennungen verursachen oder an die Anschlußklemmen angeschweißt werden.
Avvertenza	Prima di intervenire su apparecchiature collegate alle linee di alimentazione, togliersi qualsiasi monile (inclusi anelli, collane, braccialetti ed orologi). Gli oggetti metallici si riscaldano quando sono collegati tra punti di alimentazione e massa: possono causare ustioni gravi oppure il metallo può saldarsi ai terminali.
Advarsel	Fjern alle smykker (inkludert ringer, halskjeder og klokker) før du skal arbeide på utstyr som er koblet til kraftledninger. Metallgjenstander som er koblet til kraftledninger og jord blir svært varme og kan forårsake alvorlige brannskader eller smelte fast til polene.
Aviso	Antes de trabalhar em equipamento que esteja ligado a linhas de corrente, retire todas as jóias que estiver a usar (incluindo anéis, fios e relógios). Os objectos metálicos aquecerão em contacto com a corrente e em contacto com a ligação à terra, podendo causar queimaduras graves ou ficarem soldados aos terminais.
¡Advertencia!	Antes de operar sobre equipos conectados a líneas de alimentación, quitarse las joyas (incluidos anillos, collares y relojes). Los objetos de metal se calientan cuando se conectan a la alimentación y a tierra, lo que puede ocasionar quemaduras graves o que los objetos metálicos queden soldados a los bornes.
Varning!	Tag av alla smycken (inklusive ringar, halsband och armbandsur) innan du arbetar på utrustning som är kopplad till kraftledningar. Metallobjekt hettas upp när de kopplas ihop med ström och jord och kan förorsaka allvarliga brännskador; metallobjekt kan också sammansvetsas med kontakterna.

A.8 Operating Temperature and Airflow Warning



WARNING: To prevent IDU from overheating, do not operate it in an area that exceeds the maximum recommended ambient temperature of 113°F (45°C). To prevent airflow restriction, allow at least 6 inches (15.2 cm) of clearance around the ventilation openings.

Waarschuwing	Om te voorkomen dat de IDU oververhit raakt, dient u deze niet in een gebied te bedienen waar de maximaal aanbevolen omgevingstemperatuur van 45° C wordt overschreden. Om luchtstroombeperkingen te voorkomen, dient u minstens 15 cm speling rond de ventilatieopeningen te laten.
Varoitus	Jotta IDU ei kuumentuisi liikaa, sitä ei saa käyttää alueella, jonka lämpötila ylittää suositellun maksimiympäristölämpötilan 45° C. Ilmanvaihdon säilyttämiseksi on tuuletusaukkojen ympärille jätettävä ainakin 15,2 cm:n tila.
Attention	Pour éviter toute surchauffe du IDU, il est recommandé de maintenir une température ambiante inférieure à 45° C. Pour assurer une parfaite circulation de l'air autour du routeur, prévoyez un espace minimum de 15 cm autour des ouvertures de ventilation.
Warnung	Um den IDU vor Überhitzung zu schützen, vermeiden Sie Benutzung des Geräts in einer Gegend, in denen die Umgebungstemperatur das empfohlene Maximum von 45° C überschreitet. Um eine Behinderung der Luftzirkulation zu vermeiden, stellen Sie sicher, daß um die Kühlungsöffnungen herum ein Raum von mindestens 15,2 cm frei bleibt.
Avvertenza	Per evitare che il IDU si surriscalda, non utilizzatelo in una zona dove la temperatura ambiente eccede le massime raccomandate di 113° F (45° C). Per evitare di bloccare il passaggio dell'aria, lasciate almeno 6 pollici (15.2 cm) di spazio libero attorno alle aperture per la ventilazione.
Advarsel	Forhindre at IDU blir overopphetet ved å ikke bruke den på et sted der den anbefalte omgivelsestemperaturen overstiger 45° C. Unngå at luftsirkulasjonen reduseres ved å ha en klaring på minst 15,2 cm rundt ventilasjonsåpningene.
Aviso	Para impedir o sobreaquecimento do IDU, não o utilize numa área que exceda a temperatura ambiente máxima recomendada de 45° C (113° F). Para não restringir o fluxo de ar, deixe um espaço de pelo menos 15,2 cm (6 polegadas) em volta dos orifícios de ventilação.

¡Advertencia!	Para impedir que el IDU se caliente, no lo use en un área que exceda la temperatura ambiente máxima recomendada de 113° F (45° C). Con el fin de no restringir el flujo de aire, deje un espacio de un mínimo de 6 pulgadas (15,2 cm) alrededor de los orificios de ventilación.
Varning!	Förhindra att IDU chassis blir överhettad genom att inte använda den på en plats där den rekommenderade omgivningstemperaturen överstiger 45° C. Undvik att luftcirkulationen reduceras genom att ha ett fritt utrymme på minst 15,2 cm runt ventilationsöppningarna.

A.9 Lightning Activity Warning



WARNING: Do not work on the system or connect or disconnect cables during periods of lightning activity.

Waarschuwing	Tijdens onweer dat gepaard gaat met bliksem, dient u niet aan het systeem te werken of kabels aan te sluiten of te ontkoppelen.
Varoitus	Älä työskentele järjestelmän parissa äläkä yhdistä tai irrota kaapeleita ukkosilmalla.
Attention	Ne pas travailler sur le système ni brancher ou débrancher les câbles pendant un orage.
Warnung	Arbeiten Sie nicht am System und schließen Sie keine Kabel an bzw. trennen Sie keine ab, wenn es gewittert.
Avvertenza	Non lavorare sul sistema o collegare oppure scollegare i cavi durante un temporale con fulmini.
Advarsel	Utfør aldri arbeid på systemet, eller koble kabler til eller fra systemet når det tordner eller lyner.
Aviso	Não trabalhe no sistema ou ligue e desligue cabos durante períodos de mau tempo (trovoada).
¡Advertencia!	No operar el sistema ni conectar o desconectar cables durante el transcurso de descargas eléctricas en la atmósfera.
Varning!	Vid åska skall du aldrig utföra arbete på systemet eller ansluta eller koppla loss kablar.

A.10 Safety Extra-Low Voltage Port Warning



WARNING: The ports labeled "+24VDC/+48VDC", "TX Out", "10/100 LAN", "Console", "RX Out" and "RX In" are safety extra-low voltage (SELV) circuits. SELV circuits should only be connected to other SELV circuits. Avoid connecting these circuits to telephone network voltage (TNV) circuits.

Waarschuwing	De poorten die gelabeld zijn met "+24VDC/+48VDC", "TX Out", "10/100 LAN", "Console", "RX Out" en "RX In" zijn veiligheidscircuits met extra-laag voltage (SELV). SELV-circuits mogen alleen maar op andere SELV-circuits worden aangesloten. Sluit deze circuits niet op telefoonnetwerkvoltage-circuits (TNV) aan.
Varoitus	Varoitus Portit, joissa on merkintä "+24VDC/+48VDC", "TX Out", "10/100 LAN", "Console", "RX Out" ja "RX In", ovat suojattuja erittäisen alhaisen jännitteen (SELV) piirejä. SELV-piirit tulisi liittää ainoastaan toisiin SELV-piireihin. Vältä kytkemästä näitä piirejä puhelinverkkojännitteen (TNV) piireihin.
Attention	Les ports "+24VDC/+48VDC", "TX Out", "10/100 LAN", "Console", "RX Out" et « RX In » sont des circuits SELV (« Safety Extra-Low Voltage » : très basse tension de sécurité). Les circuits SELV ne devant être connectés qu'à d'autres circuits du même type, il est recommandé de ne pas les raccorder à des circuits TNV (« Telephone Network Voltage » : tension de réseau téléphonique).
Warnung	Die Ports mit der Bezeichnung "+24VDC/+48VDC", "TX Out", "10/100 LAN", "Console", "RX Out" und "RX In" sind SELV-Schaltkreise (safety extra-low voltage circuits - Sicherheits-Niedrigspannungskreise). SELV-Schaltkreise sollten nur an andere SELV-Schaltkreise angeschlossen werden. Achten Sie darauf, diese Schaltkreise nicht an TNV-Schaltkreise (telephone network voltage - Telefonnetzspannung) anzuschließen.
Avvertenza	Le porte etichettate "+24VDC/+48VDC", "TX Out", "10/100 LAN", "Console", "RX Out" e "RX In" sono circuiti di sicurezza a basso voltaggio (Safety Extra-Low Voltage SELV). Evitate di collegare questi circuiti con circuiti a voltaggio rete telefonica (Telephone Network Voltage - TNV).
Advarsel	Utgangene merket "+24VDC/+48VDC", "TX Out", "10/100 LAN", "Console", "RX Out" og "RX In" er sikkerhetskretser (SELV) med ekstra lav spenning. SELV-kretser skal bare kobles til andre SELV-kretser. Unngå å koble disse kretsene til kretser for telefonnettspenning (TNV).

Aviso	As portas assinaladas com "+24VDC/+48VDC", "TX Out", "10/100 LAN", "Console", "RX Out" e "RX In" são circuitos de segurança de baixa tensão (SELV). Os circuitos de segurança de baixa tensão só deverão ser conectados a outros circuitos de segurança de baixa tensão. Evite conectar estes circuitos a circuitos de tensão de rede telefónica (TNV).
¡Advertencia!	Los puertos "+24VDC/+48VDC", "TX Out", "10/100 LAN", "Console", "RX Out" y "RX In" son circuitos de seguridad de voltaje extra bajo (SELV). Estos circuitos SELV deben conectarse solamente a otros circuitos SELV. Evite conectar este tipo de circuitos a circuitos de la red de voltaje del teléfono (TNV).
Varning!	Portarna med beteckningen "+24VDC/+48VDC", "TX Out", "10/100 LAN", "Console", "RX Out" och "RX In" är SELV-kretsar (skyddskretsar för mycket låg spänning). SELV-kretsar får endast kopplas till andra SELV-kretsar. Undvik att koppla dessa kretsar till TNV-kretsar (kretsar med telefonnätspänning).

A.11 No On/Off Switch Warning



WARNING: Unplug the power cord before you work on a system that does not have an on/off switch.

Waarschuwing	Voordat u aan een systeem werkt dat geen aan/uit schakelaar heeft, dient u de stekker van het netsnoer uit het stopcontact te halen.
Varoitus	Ennen kuin teet mitään sellaiselle järjestelmälle, jossa ei ole kaksiasentokytkintä, kytke irti virtajohto.
Attention	Avant de travailler sur un système non équipé d'un commutateur marche-arrêt, débrancher le cordon d'alimentation.
Warnung	Bevor Sie an einem System ohne Ein/Aus-Schalter arbeiten, ziehen Sie das Netzkabel heraus.
Avvertenza	Prima di lavorare su un sistema che non è dotato di un interruttore on/off, scollegare il cavo di alimentazione.
Advarsel	Før det skal utføres arbeid på et system som ikke har en av/på-bryter, skal strømledningen trekkes ut.
Aviso	Antes de começar a trabalhar num sistema que não possua um interruptor ON/OFF, desligue o cabo de alimentação.

¡Advertencia!	Antes de trabajar sobre cualquier sistema que carezca de interruptor de Encendido/Apagado (ON/OFF), desenchufar el cable de alimentación.
Varning!	Dra ur nätsladden innan du utför arbete på ett system utan strömbrytare.

A.12 Disconnect Device Warning



WARNING: A readily accessible two-poled disconnect device must be incorporated in the fixed wiring.

Waarschuwing	Er moet een gemakkelijk toegankelijke, tweepolige stroomverbreker opgenomen zijn in de vaste bedrading.
Varoitus	Kiinteään johdotukseen on liitettävä kaksinapainen kytkinlaite, johon on helppo päästä käsiksi.
Attention	Un disjoncteur bipolaire facile d'accès doit être intégré dans le câblage fixe.
Warnung	Die feste Verdrahtung muß eine leicht zugängliche, zweipolige Trennvorrichtung enthalten.
Avvertenza	Nei cablaggi fissi va incorporato un sezionatore a due poli facilmente accessibile.
Advarsel	En lett tilgjengelig, topolet frakoblingsenhet må være innebygd i det faste ledningsnett.
Aviso	Deverá incorporar-se um dispositivo de desconexão de dois pólos de acesso fácil, na instalação eléctrica fixa.
¡Advertencia!	El cableado fijo debe incorporar un dispositivo de desconexión de dos polos y de acceso fácil.
Varning!	En lättillgänglig tvåpolig fränkopplingsenhet måste ingå i den fasta kopplingen.

A.13 Ground Conductor Warning



WARNING: Never defeat the ground conductor or operate the equipment in the absence of a suitably installed ground conductor. Contact the appropriate electrical inspection authority or an electrician if you are uncertain that suitable grounding is available.

Waarschuwing	De aardingsleiding mag nooit buiten werking gesteld worden en de apparatuur mag nooit bediend worden zonder dat er een op de juiste wijze geïnstalleerde aardingsleiding aanwezig is. Neem contact op met de bevoegde instantie voor elektrische inspecties of met een elektricien als u er niet zeker van bent dat er voor passende aarding gezorgd is.
Varoitus	Älä koskaan ohita maajohdinta tai käytä laitteita ilman oikein asennettua maajohdinta. Ota yhteyttä asianmukaiseen sähkötarkastusviranomaiseen tai sähköasentajaan, jos olet epävarma maadoituksen sopivuudesta.
Attention	Ne jamais rendre inopérant le conducteur de masse ni utiliser l'équipement sans un conducteur de masse adéquatement installé. En cas de doute sur la mise à la masse appropriée disponible, s'adresser à l'organisme responsable de la sécurité électrique ou à un électricien.
Warnung	Auf keinen Fall den Erdungsleiter unwirksam machen oder das Gerät ohne einen sachgerecht installierten Erdungsleiter verwenden. Wenn Sie sich nicht sicher sind, ob eine sachgerechte Erdung vorhanden ist, wenden Sie sich an den zuständigen elektrischen Fachmann oder einen Elektriker.
Avvertenza	Non escludere mai il conduttore di protezione né usare l'apparecchiatura in assenza di un conduttore di protezione installato in modo corretto. Se non si sa con certezza che è disponibile un collegamento di messa a terra adeguato, esaminare le Norme CEI pertinenti o rivolgersi a un elettricista qualificato.
Advarsel	Omgå aldri jordingslederen og bruk aldri utstyret uten riktig montert jordingsleder. Ta kontakt med det riktige organet for elektrisk inspeksjon eller en elektriker hvis du er usikker på om det finnes velegnet jording.
Aviso	Nunca anule o condutor à terra nem opere o equipamento sem ter um condutor à terra adequadamente instalado. Em caso de dúvida em relação ao sistema de ligação à terra, contacte os serviços locais de inspeção eléctrica ou um electricista qualificado.

¡Advertencia!	No inhabilitar nunca el conductor de tierra ni hacer funcionar el equipo si no existe un conductor de tierra instalado correctamente. Póngase en contacto con una autoridad apropiada de inspección eléctrica o con un electricista competente si no está seguro de que hay una conexión a tierra adecuada.
Varning!	Koppla aldrig från jordledningen och använd aldrig utrustningen utan en på lämpligt sätt installerad jordledning. Om det föreligger osäkerhet huruvida lämplig jordning finns skall elektrisk besiktningsauktoritet eller elektriker kontaktas.

A.14 Use Copper Conductors Only



WARNING: Use copper conductors only.

Waarschuwing	Gebruik alleen koperen geleiders.
Varoitus	Käytä vain kuparijohtimia.
Attention	Utilisez uniquement des conducteurs en cuivre.
Warnung	Verwenden Sie ausschließlich Kupferleiter.
Avvertenza	Usate unicamente dei conduttori di rame.
Advarsel	Bruk bare kobberledninger.
Aviso	Utilize apenas fios condutores de cobre.
¡Advertencia!	Emplee sólo conductores de cobre.
Varning!	Använd endast ledare av koppar.

A.15 Ground Connection Warning



WARNING: When installing the unit, the ground connection must always be made first and disconnected last.

Waarschuwing	Bij de installatie van het toestel moet de aardverbinding altijd het eerste worden gemaakt en het laatste worden losgemaakt.
Varoitus	Laitetta asennettaessa on maahan yhdistäminen aina tehtävä ensiksi ja maadoituksen irti kytkeminen viimeiseksi.
Attention	Lors de l'installation de l'appareil, la mise à la terre doit toujours être connectée en premier et déconnectée en dernier.
Warnung	Der Erdanschluß muß bei der Installation der Einheit immer zuerst hergestellt und zuletzt abgetrennt werden.
Avvertenza	In fase di installazione dell'unità, eseguire sempre per primo il collegamento a massa e disconnetterlo per ultimo.
Advarsel	Når enheten installeres, må jordledningen alltid tilkobles først og frakobles sist.
Aviso	Ao instalar a unidade, a ligação à terra deverá ser sempre a primeira a ser ligada, e a última a ser desligada.
¡Advertencia!	Al instalar el equipo, conectar la tierra la primera y desconectarla la última.
Varning!	Vid installation av enheten måste jordledningen alltid anslutas först och kopplas bort sist.

A.16 Power Supply Disconnection Warning



WARNING: Before working on a chassis or working near power supplies, unplug the power cord on AC units; disconnect the power at the circuit breaker on DC units.

Waarschuwing	Voordat u aan een frame of in de nabijheid van voedingen werkt, dient u bij wisselstroom toestellen de stekker van het netsnoer uit het stopcontact te halen; voor gelijkstroom toestellen dient u de stroom uit te schakelen bij de stroomverbreker.
--------------	---

Varoitus	Kytke irti vaihtovirtalaitteiden virtajohto ja katkaise tasavirtalaitteiden virta suojakytkimellä, ennen kuin teet mitään asennuspohjalle tai työskentelet virtalähteiden läheisyydessä.
Attention	Avant de travailler sur un châssis ou à proximité d'une alimentation électrique, débrancher le cordon d'alimentation des unités en courant alternatif ; couper l'alimentation des unités en courant continu au niveau du disjoncteur.
Warnung	Bevor Sie an einem chassis oder in der Nähe von Netzgeräten arbeiten, ziehen Sie bei Wechselstromeinheiten das Netzkabel ab bzw. schalten Sie bei Gleichstromeinheiten den Strom am Unterbrecher ab.
Avvertenza	Prima di lavorare su un telaio o intorno ad alimentatori, scollegare il cavo di alimentazione sulle unità CA; scollegare l'alimentazione all'interruttore automatico sulle unità CC.
Advarsel	Før det utføres arbeid på kabinettet eller det arbeides i nærheten av strømforsyningsenheter, skal strømfledningen trekkes ut på vekselstrømsenheter og strømmen kobles fra ved strømbryteren på likestrømsenheter.
Aviso	Antes de trabalhar num chassis, ou antes de trabalhar perto de unidades de fornecimento de energia, desligue o cabo de alimentação nas unidades de corrente alternada; desligue a corrente no disjuntor nas unidades de corrente contínua.
¡Advertencia!	Antes de manipular el chasis de un equipo o trabajar cerca de una fuente de alimentación, desenchufar el cable de alimentación en los equipos de corriente alterna (CA); cortar la alimentación desde el interruptor automático en los equipos de corriente continua (CC).
Varning!	Innan du arbetar med ett chassi eller nära strömförsörjningsenheter skall du för växelströmsenheter dra ur nätsladden och för likströmsenheter bryta strömmen vid överspänningskyddet.

A.17 Power Cabling Warning



WARNING: Secure all power cabling when installing this unit to avoid disturbing field-wiring connections.

Waarschuwing	Zet alle stroomkabels vast wanneer dit toestel wordt geïnstalleerd om te voorkomen dat de verbindingen van de veldbedrading worden verstoord.
Varoitus	Kiinnitä kaikki voimakaapelit tiukkaan tätä laitetta asentaessasi, jotta vältät kentän johdinkytkentöjen vioittumista.
Attention	Lors de l'installation de cet appareil, fixer tous les câbles d'alimentation pour éviter de provoquer des perturbations aux raccordements des câblages propres au site.
Warnung	Bei der Installation dieser Einheit die Netzverkabelung befestigen, um die Störung von Feldkabelanschlüssen zu vermeiden.
Avvertenza	In fase di installazione dell'unità, assicurare tutti i cablaggi di alimentazione per evitare di alterare i collegamenti degli avvolgimenti di campo.
Advarsel	Når denne enheten installeres, må alle kraftledninger sikres for å unngå at feltkabelkoblingene forstyrres.
Aviso	Para evitar problemas com as ligações de rede de campanha, prenda todos os cabos de corrente quando instalar esta unidade.
¡Advertencia!	Sujetar todo el cableado de alimentación cuando se instale este equipo para evitar que se mezcle con las conexiones del cableado "in situ".
Varning!	Fäst allt starkströmskablage vid installation av denna enhet så att fältkopplingen inte rubbas.

A.18 AC Power Supply Circuit Warning



WARNING: Care must be given to connecting units to the supply circuit, so that wiring is not overloaded.

Waarschuwing	Let erop dat de toestellen op voedingscircuits worden aangesloten zonder het vermogen van de bedrading te overschrijden.
Varoitus	Laiteyksiköt on yhdistettävä huolellisesti syöttöpiiriin niin, että johdot eivät ole ylikuormitettuja.
Avertissement	Veillez à bien connecter les unités au circuit d'alimentation afin de ne pas surcharger les connections.
Achtung	Beim Anschließen der Geräte an das Stromnetz ist darauf zu achten, daß die Schaltverbindungen nicht überlastet werden.
Avvertenza	Fare attenzione quando si collegano le unità al circuito di alimentazione, per non sovraccaricare i cablaggi.
Advarsel	Vær nøye med å koble enheter til strømforsyningskretsen slik at ledningene ikke overbelastes.
Aviso	Deverá ter precaução ao ligar unidades ao circuito de fornecimento de energia, para não sobrecarregar a instalação.
¡Atención!	Poner mucho cuidado al conectar los equipos al circuito de alimentación a fin de no sobrecargar el cableado.
Varning!	Var noga vid anslutning av enheter till matarströmkretsen så att ledningarna inte överbelastas.

B: Compliance

This appendix provides international agency compliance, safety, and statutory information for the iDirect 3000 series™ Satellite Router. Please also refer to the EC-Declaration of Conformity at the end of this section.

NOTE: Triple DES Encryption is eligible for export from the U.S. to all customers worldwide, except to U.S. embargoed destinations. Other countries may exercise separate jurisdiction over the import, export, or use of encryption products. Users who use this product should observe any local regulations that may apply to the distribution or use of encryption products.

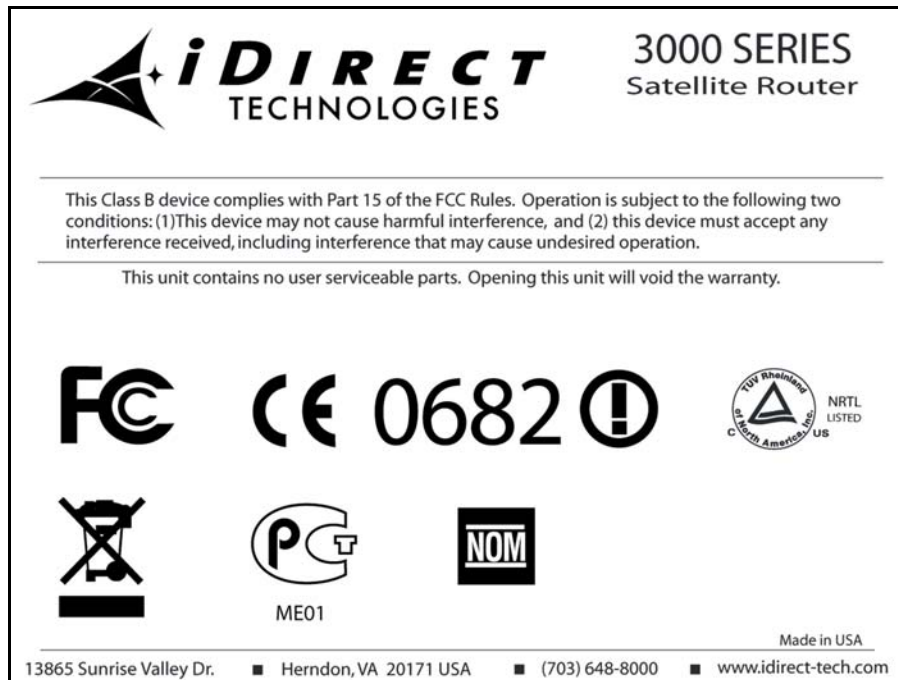

Figure 21 iDirect 3000 series™ Satellite Router Product Label

B.1 FCC Compliance



The iDirect 3000 series™ Satellite Routers comply with Class B of Part 15 of the FCC (Federal Communications Commission) rules as is identified by use of the FCC logo.

Radiated and Conducted
Emission

47CFR15 Class B, CISPR-22 Class B, EN55022 Class B.

B.2 Part 15 Compliance

This equipment has been tested and found to comply with the limits for a Class B digital device, pursuant to Part 15 of the FCC rules. These limits are designed to provide reasonable protection against harmful interference in a residential installation. The equipment uses, generates, and radiates frequency energy. If the equipment is not installed and used in accordance with the instructions, it may cause harmful interference to radio communications. There is also no guarantee that interference will not occur in a particular installation. You can determine if the equipment is interfering with radio or television reception by removing or applying power to the equipment and seeing if the interference goes away, or returns, when the unit is off or on.

To meet FCC requirements, only peripherals, such as computer input/output devices, terminals, and printers certified to comply with the Class B limits, may be attached to this device. Operation with non-certified peripherals is likely to result in interference to radio and TV reception.

To meet FCC requirements, shielded cables are required to connect the device to a personal computer, peripheral, or other Class B certified device.



Modification of this equipment without written authorization from iDirect Technologies may result in this equipment no longer complying with FCC requirements for Class B digital devices. In that event, your right to use the equipment may be limited by FCC regulations, and you may be required to correct any interference to radio or television communications at your own expense.

B.3 Canadian Labeling Requirements

iDirect 3000 series™ Satellite Routers meet Canadian labeling requirements.

This Class B digital apparatus complies with Canadian ICES-003.

Cet appareil numérique de la Classe B est conforme à la norme NMB-003 du Canada.

B.4 CE Compliance (European Union)



Marking by this symbol indicates the iDirect 3000 series™ Satellite Routers are in compliance with all relevant European Radio and Telecommunications Terminal Equipment (R&TTE) Directives. This Class 2 equipment has been registered with the European Notified Body 0682 (NB).

EMC Emission	EN301428, EN301443, EN300673, EN55022, EN61000-3-2, EN61000-3-3
EMC Radio Spectrum Matters	EN 61000-4-2, EN 61000-4-3, EN 61000-4-4, EN 61000-4-5, EN 61000-4-6, EN 61000-4-11, ISO7637
EMC Immunity	EN301489-1 Part 12
Health	R&TTE Article 3.1a, DIN VDE 0848 Part1, FCC OET Bullet Number 65
Safety	IEC/EN60950 - 1

B.5 Safety



TUV Rheinland of North America is a Nationally Recognized Testing Laboratory (NRTL) in the United States and is accredited by the Standards Council of Canada to test and certify products to Canadian National Standards. The iDirect 3000 series™ Satellite Router is in compliance to both U.S. and Canadian National Standards on Safety.

In addition, the IECEE CB Scheme Test Report and CB Test Certificate for the iDirect 3000 series™ Satellite Router is done with TUV Rheinland of North America. This CB Scheme is recognized by the multilateral agreement among participating countries and certification organizations. Since iDirect is utilizing this CB test report issued by TUV, the iDirect 3000 series™ Satellite Router is in compliance with all other member countries of the CB Scheme.

Safety

UL60950-1 / CAN/CSA-C22.2 NO. 60950-1 -03

B.6 RoHS and WEEE Compliance

This section briefly describes the European Union RoHS and WEEE Directives. It also presents an overview of iDirect Technologies compliance to these directives.

B.6.1 Compliance with RoHS Directive (2002/95/EC)

The European Union passed the Restriction of Hazardous Substances (RoHS) Directive into law. It affects manufactures, sellers, distributors, and recyclers of electrical and electronic equipment containing lead, cadmium, mercury, hexavalent chrome, polybrominated biphenyl (PBB) and polybrominated diphenyl ether (PBDE). As of July 1, 2006, the use of these materials is banned in new products sold in Europe. The RoHS Directive complements the WEEE Directive. iDirect Technologies is committed to protecting people and the environment and we are identifying any materials used in our processes that could pose a potential hazard to our employees, customers, or the environment.

All iDirect Technologies products shipped to the European Union after July 1, 2006 comply with the 2002/95/EC directive.

B.6.2 Compliance with WEEE Directive (2002/96/EC)

The Waste Electrical and Electronic Equipment Directive (WEEE) applies to companies that manufacture, sell, distribute, or treat electrical and electronic equipment in the European Union. WEEE covers all large and small household appliances, IT equipment, radio and audio equipment, electrical tools, and telecommunication equipment.

The directive aims to reduce the waste arising from electrical and electronic equipment and to improve the environmental performance of all those involved in the lifecycle of these products.

According to this directive producers have a certain responsibility regarding their products in the waste phase. iDirect Technologies is offering its clients a take-back solution for iDirect waste products all over Europe. Details can be found on the iDirect Technologies website located at:

<http://www.idirect.net/page.ww?section=Company&name=Environmental+Responsibility>

You can also contact us via email at weeepickup@idirect.net or call 888-362-5475, extension 8026.

B.7 Declaration of Conformity

Manufacturer/Responsible Person:		iDirect Technologies Inc. Hai Tang/Greg Braunberg
Address:		13865 Sunrise Valley Drive Herndon, VA 20171 USA
Declares that the Product:		
Type:		VSAT System
Model:		NetModem II Plus, Private HUB, MUSiC Box, NetModem Hub 1-IF, NetModem Hub 5-IF, iINFINITY Series 1000, 3000, 5000, 7000, 10000, 15000
Intended Use:		Satellite Router System
Complies with the essential requirements of Article 3 of the R&TTE 1999/5/EC Directive, if used for its intended use and that the following standards has been applied:		
1. Health (Article 3.1a of the R&TTE Directive)		
Applied Standard(s):		DIN, VDE 0848 Part 1 (2000-08), 1999/519/EC (1999-07) which refers to ICNIRP Guidelines, FCC OET Bullet No. 65, Edition 97-01, August 1997
Issue:		August 2, 2001
2. Safety (Article 3.1a of the R&TTE Directive)		
Applied Standard(s):		EN 60950: 2001
Issue:		Aug., 2001, July 2002, Nov 2003, Feb 2005
3. Electromagnetic compatibility (Article 3.1b of the R&TTE Directive)		
Applied Standard(s):		EN 300 673, EN301 489-1, V1.2.1, EN 301 489-12 V1.1.1
Issue:		Aug. 2001, Aug. 2002, July 2003, Jan 2005
4. Efficient use of the radio frequency spectrum (Article 3.2 of the R&TTE Directive)		
Applied Standard(s):		Final Draft ETSI EN 301 428 V1.2.1 (2001-02) ETSI EN 301 443 V1.2.1 (2001-02)
Issue:		Aug. 2001, July 2002, July 2003, Jan 2005
Herndon, VA USA		
July 1, 2006		
Place Of Issue	Date Of Issue	Hai Tang Director – Hardware Engineering