

TwistPort™ Shielded Adaptor

for RouterBoard



TwistPort™ Shielded Adaptor for RouterBoard

1

Package Contents

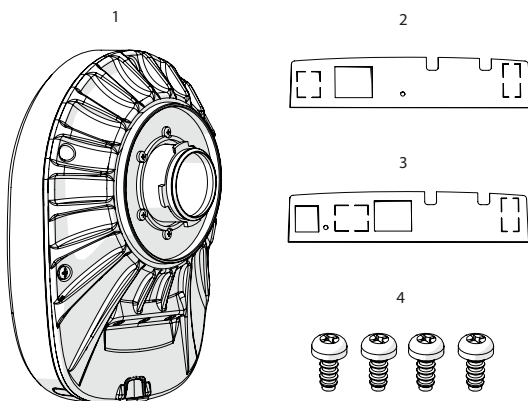

Number	Description	Quantity
1	TwistPort™ Adaptor RB Body	1x
2	TwistPort™ Adaptor RB Sticker A	1x
3	TwistPort™ Adaptor RB Sticker B	1x
4	2,9 x 6,5mm Screw	4x

TwistPort™ Shielded Adaptor for RouterBoard

2

Installation Guide

1

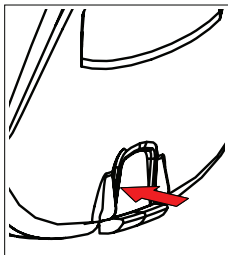

2

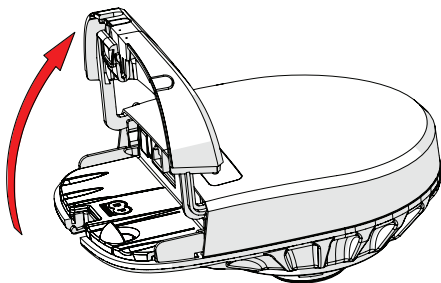
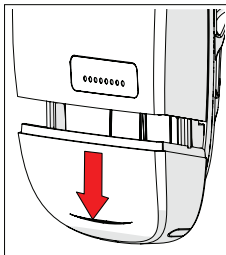

TwistPort™ Shielded Adaptor for RouterBoard

3

Installation Guide

1

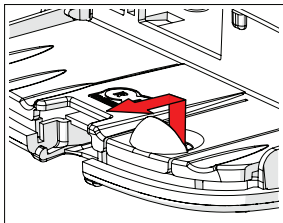

2

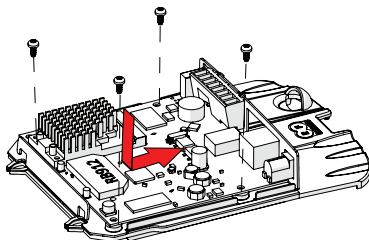
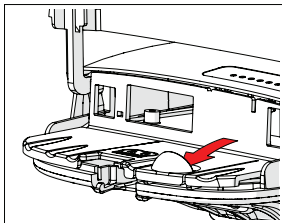

3

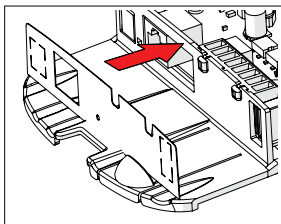

TwistPort™ Shielded Adaptor for RouterBoard

Installation Guide

1

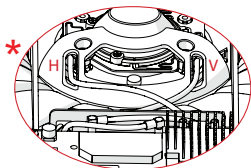
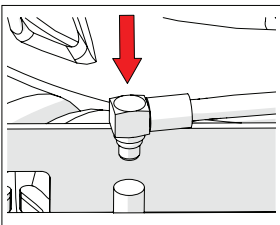

2

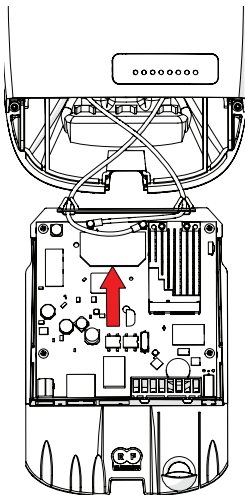
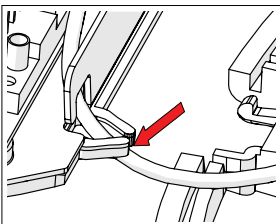

3

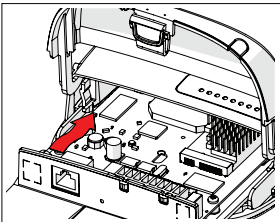

* Antenna Port H - Horizontal Polarization
Antenna Port V - Vertical Polarization

TwistPort™ Shielded Adaptor for RouterBoard

Installation Guide

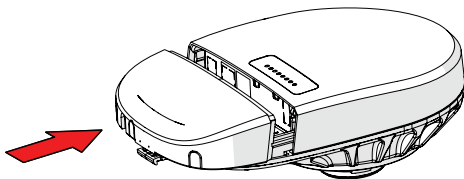
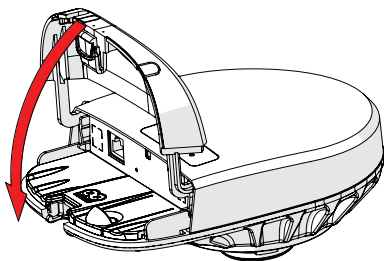

TwistPort™ Shielded Adaptor for RouterBoard

6

Installation Guide

1

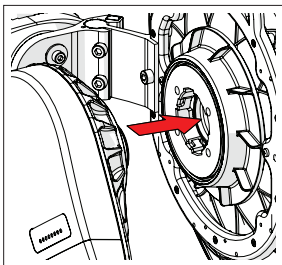

2

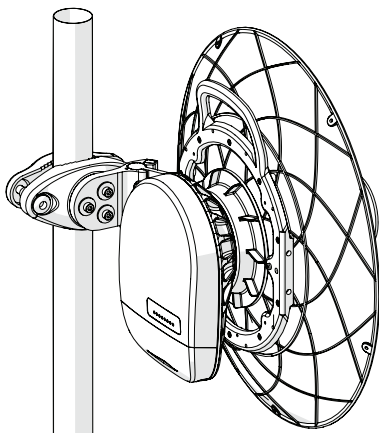
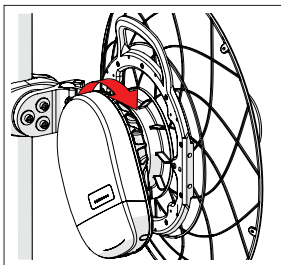

TwistPort™ Shielded Adaptor for RouterBoard

7

Installation Guide

1

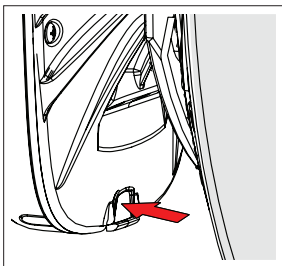

2

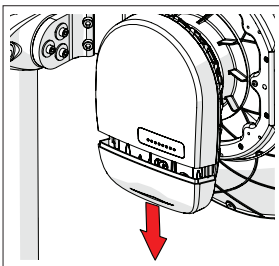

3

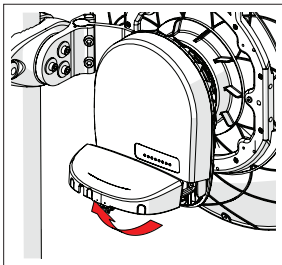

4

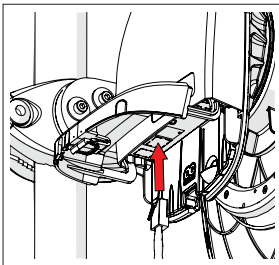

TwistPort™ Shielded Adaptor for RouterBoard

8

Installation Guide

1

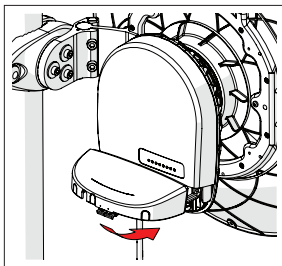

2

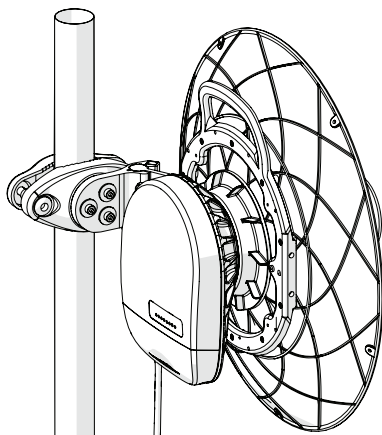
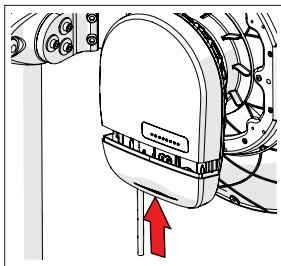

Compatible Devices:

MikroTik™ RB

RouterBoard™ 9 series

MikroTik RB91x*, RB92x*

RouterBoard™ 7 series

MikroTik RB71x*

RouterBoard™ 4 series

MikroTik RB41x*

*NOT ALL RADIO CARDS MAY FIT

Compatible Antennas:

RF elements®

any Symmetrical Horn TP Antenna

any UltraDish™ TP Antenna

MikroTik™ and RouterBoard™ are trademarks of MikroTik,
Aizkraukles iela 23, Riga, LV-1006 Latvia.

RF elements®, UltraDish™ and TwistPort™ are trademarks
of RF elements s.r.o., Humenne, Slovakia.
All rights of trademark owners reserved.



RF elements s.r.o.

Phone: +421 2 3260 3711

info@rfelements.com

www.rfelements.com