

Symmetrical Horn Carrier Class

SH-CC 5-30

CONNECTORIZED SYMMETRICAL HORN ANTENNA WITH CARRIER CLASS PERFORMANCE

The SH-CC Series offer unique RF performance in a very compact package. Scalar horn antennas have symmetrical beams with identical patterns in the Vertical and Horizontal plain. Extremely small side lobes secure greatly decreased interference.

SH-CC Antennas are ideal for covering areas with close in clients where null zone issues occur. High density AP clusters and radio co-location is now practical due to very unique RF radiation patterns and compact size.

SH-CC 5-30 antenna is equipped with N-female connectors.



TECHNICAL DATA

Radio Connection	2x N Female Bulkhead Connector
Antenna Type	Horn
Materials	UV Resistant polycarbonate, Polypropylene, Aluminium, Zinc, Stainless Steel
Environmental	IP55
Pole Mounting Diameter	15-86 mm
Temperature	-30°C to +55°C (-22°F to +131°F)
Wind Survival	160 km/hour
Mechanical Tilt	± 25°
Weight	2.3 Kg / 5.1 lbs* – single unit 3.2 Kg / 7.1 lbs* – single unit incl. package N/A Kg / lbs – carton (N/A units)
Single Unit	Retail Box: 33 x 30 x 23 cm*
N/A Units	Carton Box: N/A

*Estimation based on pre-production units. Subject to change.

PERFORMANCE

Frequency Range	5180 - 6100 MHz
Gain	18.5 dBi
Azimuth/Elevation Beam Width -3 dB	H 21° / V 21°
Azimuth/Elevation Beam Width -6 dB	H 30° / V 30°
Front-to-Back Ratio	41 dB
VSWR Max	1.8
Polarization	Dual Linear H + V
Impedance	50 Ohm

PRODUCT DIMENSIONS

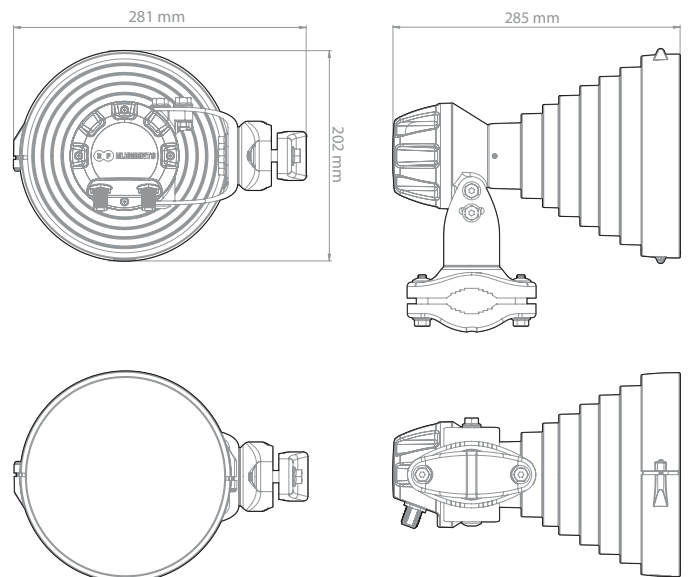

AZIMUTH PATTERN



V/H - Port Pattern Azimuth 5.6 GHz

ELEVATION PATTERN

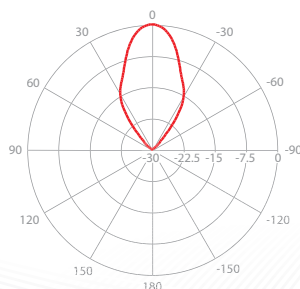

V/H - Port Pattern Elevation 5.6 GHz

GAIN

