

\*The specifications are subject to changes without notice.  
\*The company reserves the right of final interpretation and correction.

Version 1.0

# COSUPER

## USER MANUAL

Maximum Power Point- CMP Series

CMP Series



Solar charge controller



Trading Company: Suzhou Cosuper Energy Technology CO.,LTD  
Manufacturer: Suzhou Develpower Energy Equipment Co.,LTD

Add: No.99 Gangtian Road,  
Suzhou Industrial Park,215121,China  
Tel: +86 512 68638910  
Fax: +86 512 68638916  
E-mail: info@cosuper.com  
Web: www.cosuper.com



# »» TABLE OF CONTENTS

Important Safety Information .....	1
A. General Safety Precautions .....	1
B. Precautions When Working with Batteries .....	1
I. Features .....	2
II. Charging introduction .....	2-3
III. Connection .....	4
1. For one machine operation .....	4
2. For parallel operation .....	4
V. Panel introduction .....	5
1. Fix the hooks .....	5
2. Charging indication .....	5
3. Battery indication .....	6
4. Cooling fin .....	6
5. LCD display and keys operation .....	6
IV. Instructions .....	9
VI. Networking introduction .....	9
VII. PC monitoring .....	9
VIII. Installation instructions .....	10-11
X. Environmental requirements .....	12
IX. Protections .....	12
XI. Fault code .....	13
i Parameters .....	13
ii Conversion efficiency .....	15
iv. Dimension .....	16
XII. Warranty .....	17

## Important Safety Information



This manual contains important instructions for all XPT Inverter/Charger models that shall be followed during installation and maintenance of the inverter.

### A. General Safety Precautions

1. Before installing and using the XPT Inverter/Charger, read all instructions and cautionary markings on the XPT Inverter /Charger and all appropriate sections of this guide. Be sure to read all instructions and cautionary markings for any equipment attached to this unit.
2. This unit is designed for indoor use only. Do not expose the XPT Inverter/Charger to rain, snow, or spray.
3. To reduce risk of fire hazard, do not cover or obstruct the ventilation openings. Do not install the XPT Inverter/Charger in a zero-clearance compartment. Overheating may result.
4. Use only attachments recommended or sold by the manufacturer. Doing otherwise may result in a risk of fire, electric shock, or injury to persons.
5. To avoid a risk of fire and electric shock, make sure that existing wiring is in good condition and that wire is not undersized. Do not operate the XPT Inverter/Charger with damaged or substandard wiring.
6. Do not operate the XPT Inverter/Charger if it has received a sharp blow, been dropped, or otherwise damaged in any way. If the XPT Inverter/Charger is damaged, see the Warranty section.
7. Do not disassemble the Inverter/Charger. It contains no user-serviceable parts. See Warranty for instructions on obtaining service. Attempting to service the XPT Inverter/Charger yourself may result in a risk of electrical shock or fire. Internal capacitors remain charged after all power is disconnected.
8. The XPT Inverter contains more than one live circuit (batteries and AC line). Power may be present at more than one source. To reduce the risk of electrical shock, disconnect both AC and DC power from the XPT Inverter/Charger before attempting any maintenance or cleaning or working on any circuits connected to the XPT Inverter/Charger. Turning off controls will not reduce this risk.
9. Use insulated tools to reduce the chance of short-circuits when installing or working with the inverter, the batteries, or PV array.

### B. Precautions When Working with Batteries

1. Make sure the area around the battery is well ventilated.
2. Never smoke or allow a spark or flame near the engine or batteries.
3. Use caution to reduce the risk of dropping a metal tool on the battery. It could spark or short circuit the battery or other electrical parts and could cause an explosion.
4. Remove all metal items, like rings, brace lets, and watches when working with lead-acid batteries. Lead-acid batteries produce a short circuit current high enough to weld metal to skin, causing a severe burn.
5. Have someone within range of your voice or close enough to come to your aid when you work near a lead-acid battery.
6. Have plenty of fresh water and soap near by in case battery acid contacts skin, clothing, or eyes.
7. Wear complete eye protection and clothing protection. Avoid touching your eyes while working near batteries.
8. If battery acid contacts skin or clot hing, wash immediately with soap and water. If acid enters your eye, immediately flood it with running cold water for at least twenty minutes and get medical attention immediately.
9. If you need to remove a battery, always remove the grounded terminal from the battery first. Make sure all accessories are off so you don't cause a spark.
10. Always use identical types of batteries.
11. Never install old or untested batteries. Check each battery's date code or label to ensure age and type.
12. Batteries are temperature sensitive. For optimum performance, the should be installed in a stable temperature environment.
13. Always recycle old batteries. Contact your local recycling center for proper disposal information.

## I. Features

1. Can be used in all kinds of bad environment with Aluminum frame.
2. Double crest or multi crest tracing technique design, when the solar panel is under shadow or part of the solar panel is damaged, multi crest will turn up in I-V curve, and the controller can still trace the Max. Power Point.
3. Built-in maximum power point tracking algorithm which could promote energy utilization efficiency of pv system. The charging efficiency is 15%~20% higher than PWM mode.
4. Adopting sorts of tracking algorithm to track the best working point of I-V curve promptly and accurately, the MPPT efficiency could reach to 99.9%
5. The use of advanced digital power technology, circuit energy conversion efficiency is as high as 98%
6. Four stage charging order mode: MPPT-equalizing charging-boost charging-float charging.
7. With current-limiting charging mode, when the power of solar panel is over-sized and charging current exceeds the rated current, the controller will lower the charging power, which enables the system to work under the rated charging current.
8. It can communicate with PC by communication wires and cables, read or set controller's running parameters and monitor the system operation status.
9. The controller can realize networking operation by the link with telecommunication cable.
10. Have the fault code indication; it helps users confirm the system fault
11. 12V/24V/36V/48V auto identified.
12. Support data storage, the storage span can reach 5 years.
13. It can connect with LCD screen monitoring and the controller parameters are amendable.
14. Built-in temperature sensor, when the temperature exceeds the set value, the charging current will lower down followed by the decrease of temperature, so as to control the controller's temperature rise.
15. With temperature compensation function to adjust the charge and discharge parameters automatically, which can improve battery service life.
16. Various system protection functions. Including over-charge, over-discharge, over-load, over-heat, the battery reverses connection protection and so on.
17. TVS lighting protection.

## II. Charging introduction.

The full name of the MPPT is maximum power point tracking. It is an advanced charging way which could detect the real-time power of the solar panel and the maximum point of the I-V curve that make the highest battery charging efficiency. Contrast with the traditional PWM controller, MPPT controller could play a maximum power of the solar panel so that a larger charging current could be supplied. Generally speaking, the MPPT controller's energy utilization efficiency is 15%~20% higher than PWM controller.

The voltage of the solar panel is about 12V when General controller is charging while the highest voltage of the solar panel is about 17V, so it doesn't play the largest power of the solar panel. MPPT controller overcome this problem by adjusting the input current and voltage constantly to realize the largest input power.

Meanwhile, the maximum power point will change due to the surrounding temperature and sunshine condition. MPPT controller will adjust the parameter constantly according to different conditions to make the system working in the largest power point.

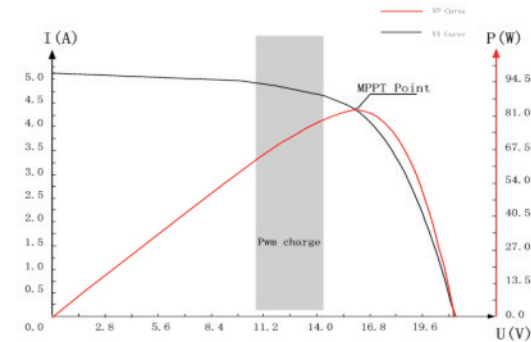

MPPT controller will adjust the parameters constantly according to different conditions to make the system working in the largest power point.

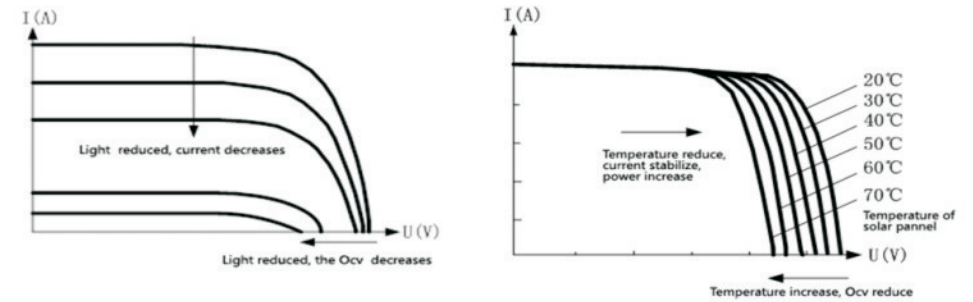

As a charging stage, MPPT charging can't work alone, it should combine with boost charging, float charging and equalizing charging. When the controller works, it will identify the battery voltage, if the voltage exceeds  $13.2(\times 2 / 24)V$ , it will enter float charging directly without equalizing charging or boost charging. If the battery charging voltage is lower than  $13.2V(\times 2 / 24V)$ , the charging process is: MPPT(equalizing charging)—boost charging—float charging, the equalizing charging time is 1h, boost charging time is 2h, equalizing charging interval is 30 days, the charging curve is as follows:

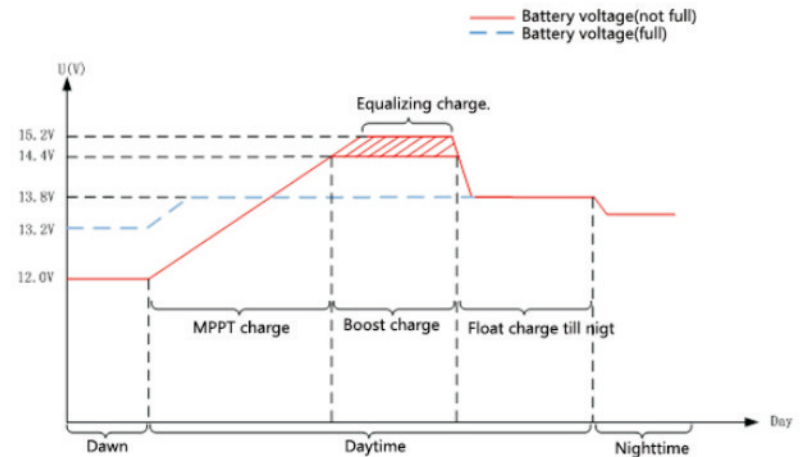

### III. Connection

#### 1. For one machine operation:

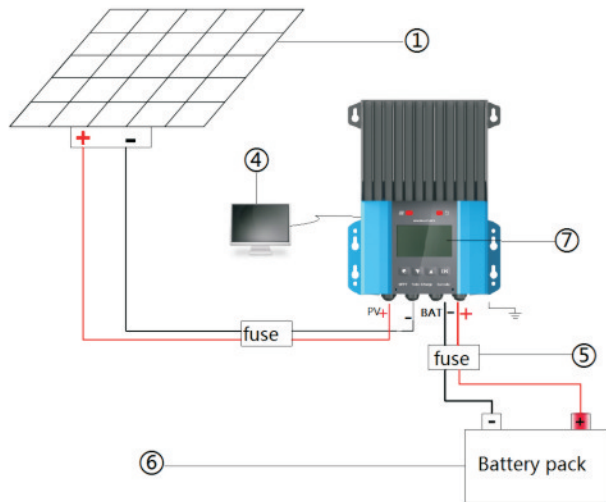

#### 2. For parallel operation:

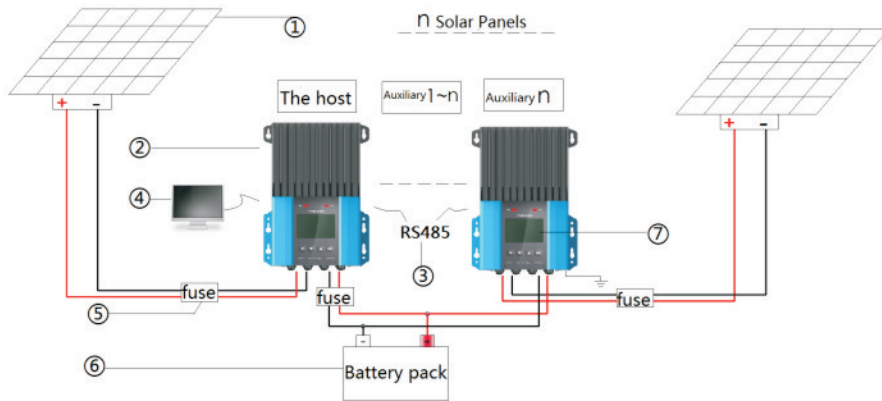

1. Solar panel.  
The power for battery charging.
2. Controller.  
Central nervous of the system which controls the overall system.
3. RS485 Telecommunication cable.  
Communication line of the controller which is necessary for parallel operation.
4. PC.  
It can realize info exchange with the controller by RS232 and can monitor the system timely.

5. Open space.  
It can insure the safety of operators.(the switching element is optional).
6. Battery.  
A battery pack which compose of battery in series or in parallel.
7. LCD display.  
The LCD can display the system status, parameters, records and the set value. (You can just choose one communication way: PC or LCD).

### V. Panel introduction.

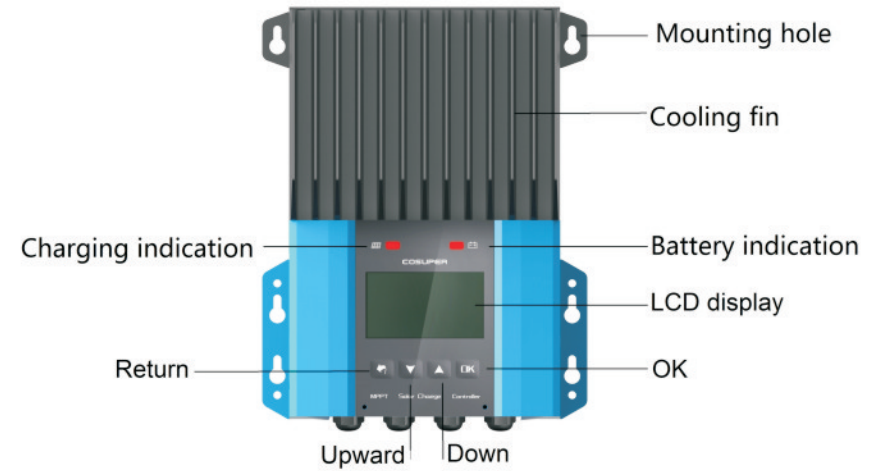

**1. Fix the hooks.**  
Used for the installation of the controller.

#### 2. Charging indication.

##### CHARGE STATUS

	BULK	Always on, charge as the Max. Power
	ACCEPTANCE	Flash slowly, boost voltage
	FLOAT	Single flash, float charge
	EQUALIZE	Quick flashing, equalizing charge
	CURRENT-LIMITED	Double flash, current limiting charge

Serial number	Status	Charging stage
1	Normally on.	Charging at Max. Power.
2	Slow flash.(light for 1s, off for 1s, the cycle is 2s)	Boost charging.
3	Single flash.(light for 0.1s, off for 1.9s, the cycle is 2s)	Float charging.
4	Fast flash.(light for 0.1s, off for 0.1s, the cycle is 0.2s)	Equalizing charge.
5	Double flash.(light for 0.1s, off for 0.1s, reopen for 0.1s, reclose for 1.7s, the cycle is 2s)	Current limited charging.
6	Off	Night







### 3.Battery indication.

Indication	Battery status
Normally on	The voltage is normal.
Slow flash (light for 1s, off for 1s, the span is 2s)	It is over discharge.
Fast flash. (light for 0.1s, off for 0.1s, the cycle is 0.2s)	It is over voltage.

### 4.Cooling fin.

Provide heat dissipation for the controller, the cooling fin will be heat when the controller runs, please do not touch the face of the controller.

### 5.LCD display and keys operation.

The display section have two-stage menu, there are main menu and side menu, the main manu has three items, each item has its side menu, the second side menu is parameter setting menu, the others are parameter viewing menu. It has 4 independent function keys, from left to right is: “” “” “” “” key, the function of “” key, is to return to previous menu or return to last status, the function of “” key, is to select or set parameters, the function of “” key is to enter into next menu, or enter into parameter setting or confirm the parameters(More details please check SR-RM-2 parts specification).

#### A.Homepage menu comparison table

Menu table-1		
Serial number	Name	LCD display content
1	System status	System Data
2	System configuration	System Configuration
3	Product info	Product Info

 “System Data” is the menu to examine the system status, the detail displaying status items, please check’ menu table-11’; “System Configuration “is the menu to set system running parameters, the detail parameters, please check’ menu table-12’, “Product Info “is the menu to examine equipment info, the detail info, please check’ menu table-13’.

#### B.System submenu comparison table.

Serial number	name	LCD display	Parameter sample
1	charging stage	Chg-stag:	IDLE
2	battery voltage	U-bat:	55.5V
3	solar panel voltage	U-pv:	100.5v
4	charging current	I-chg:	30.9A
5	load status	Load:	ON
6	discharging current	I-load:	0.0A
7	battery capacity(SoC)	Soc:	100%
8	temperature	Temp:	25℃
9	charging power	P-chg:	900W
10	discharging power	P-load:	1.25kw
11	the max voltage	Vmax:	60.9V
12	the min voltage	Vmin:	52.8V
13	charging capacity(AH)	C-chg:	999AH
14	discharging capacity(AH)	C-load:	0AH
15	charging capacity(WH)	E-chg:	999WH
16	discharging capacity(WH)	E-load:	0WH
17	running days	Rundays:	100D
18	over-discharge times	LVD-CNT:	10
19	full charge times	FUL-CNT:	100
20	fault code	Fault:	1

 The submenu of the system can check the current running parameters such as battery voltage, charge-discharge current, and fault code and so on; it does good to system maintenance.

### C. System configuration submenu comparison table

Serial number	name	LCD display	Parameter sample
1	over voltage discharge	OVD:	16.0~17.0V
2	charging limited voltage	CLV:	15.5~16.0V
3	equalizing charge voltage	ECV:	15.0~15.5V
4	boost charge voltage	BCV:	14.0~15.0V
5	float charge voltage	FCV:	13.2~14.0V
6	boost return voltage	BCV-R:	12.3~13.5V
7	low voltage reconnect	LVR:	12.0~13.0V
8	under voltage warning	UVW:	11.3~12.5V
9	low voltage disconnect	LDV:	9.8~11.8V
10	equalizing charge duration	EQV-T:	1~3H
11	boost charge duration	BST-T:	1~3H
12	equaling charge interval	EQV-Inv:	3~30D
13	temperature compensation coefficient	TEMP-Com:	3~5
14	load mode	L-Mode:	0~17
15	light control voltage	L-CON-V:	5~11V
16	controller address	Address:	1~99

 The configurable items and configuring range of system configuration submenu are as the above table, please operate cautiously, when setting the parameters to insure the proper operation of the system.

### D. Product info submenu comparison table

Serial number	name	Item	Parameter sample
1	model	Model:	SR-MPPT45
2	hardware version number	HW-ver:	01.01.01
3	software version number	SW-ver:	01.01.01
4	series number	Serial:	9999999

 Product info submenu, which displays the model, hardware version, software version and serial number.

## IV. Instructions.

1. The controller will identify the battery voltage automatically. Please connect the battery first and ensure the connection is reliable, if you need parallel operation, please electrify the slave engine first, otherwise it will identify the system volt wrongly.
2. MPPT controller is designed according to solar panel's I-V curve, so when the controller connect the general constant voltage DC source, the controller may not work.
3. Advice is installed in the ventilated and heat dissipated environment due to the controller will fever during operation.
4. The controller will detect the surrounding temperature to compensate the battery charging voltage so ensure the controller and battery is in the same environment.
5. Choosing the proper cable with enough capacity to avoid redundant power loss in the circuit. Too much circuit loss may lead to wrong judgment.
6. Full charge is very important for the battery. The battery should be full charged at least once a month or the battery will suffer permanent damage. The battery can be full charged only when the input power of the battery is more than power consumption of the load.
7. Please do not dip the controller into the corrosive liquid or the controller will be damaged and release harmful gas.
8. The solar panel's terminal voltage may exceed human safety voltage when connect 24V system, when manipulation is needed, please use insulating tools and ensure the hands dry.
9. Because the battery store lots of energy, do not allow the battery short circuit in any case. We suggest tandem connect a fuse on the battery
10. The battery may release combustible gas, please far away from the spark.
11. Ensure the children are far away from battery and controller
12. Please abide by the battery manufacturer's safety suggestion.

## VI. Networking introduction.

The controller supports parallel operation, before working, please set different addresses for each controller; the controller's factory default is slave engine, and it can be customized into main engine. More details please check SR-RM-2 parts specification.

## VII. PC monitoring.

The controller can communicate with PC.

1. Firstly, connect the enclosure USB 232 wire with controller and PC.
2. Install USB 232 drive by use of the enclosure CD.(When you use it at first time).
3. Open the upper computer software, select the port and click to link. If connect succeed, it means that the controller has set up communication with the PC, if not, please check the port.

## VIII. Installation instructions.

1. Loosen the four screws and open the panel (picture 1).
2. Please take away both the baffle of front and side wiring hole and take out the water joint from the accessory, install it in the wiring hole.
3. Cross the side plate by use of suitable energize wire rod and telecommunication cable. (picture 2).
4. Fix the wire rod successively to controllers inside wiring terminal (picture 3).
5. Close the panel after connecting the LCD and telecommunication cable (parallel operation is needed), and then tighten the screws (picture 4).
6. Fix the controller at the installation place.

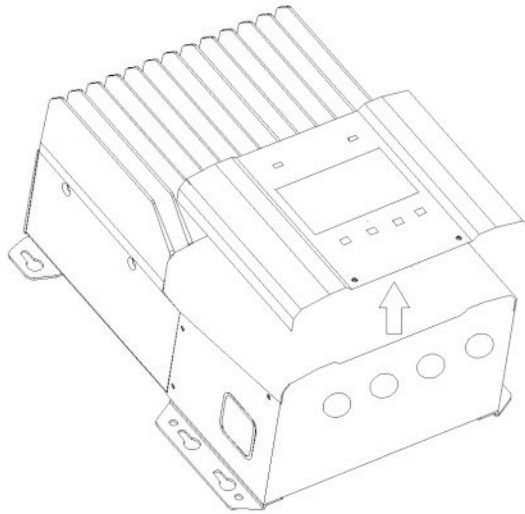

【Picture1】

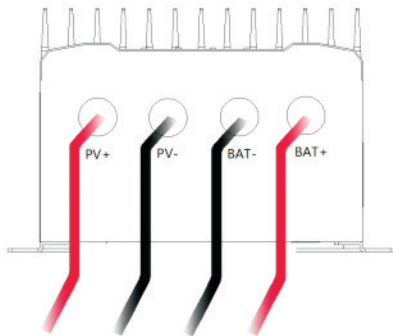

【Picture2】

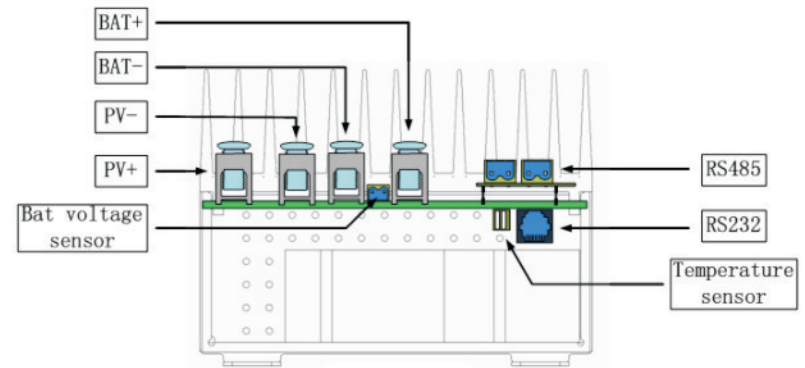

【Picture3】

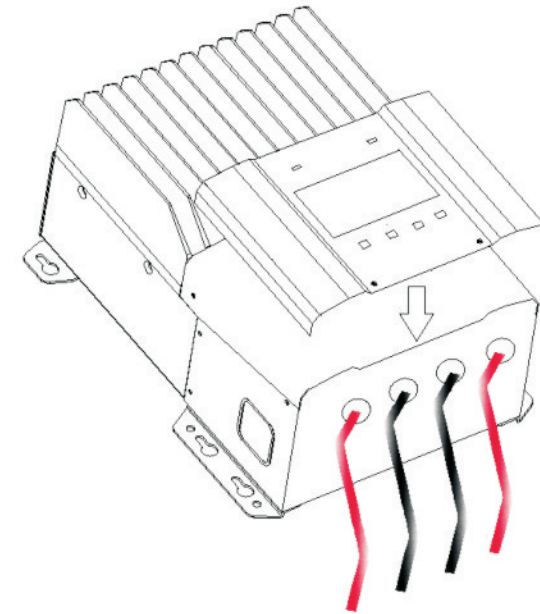

【Picture4】

### 7. Power on.

- ⚠ Battery short circuit is prohibited; do not touch the solar panel or the bare part of battery wiring.
- ⚠ Choose the cable, do not exceed the current density of 4A/1mm, please make sure the wiring is correct.
- 💡 Do not reverse connect the wire, leave an air switch between battery and controller or between solar panel and controller, open the battery air switch after completion of above job, and then open the solar panel air switch; The installation site is suggested to be aeration-drying; start the slave first, if it is main engine, please set it as slave. Ensure that the system is run by one main engine and start it in the end.

## X. Environmental requirements.

1. Working ambient temperature range:  $-35^{\circ}\text{C} \sim +45^{\circ}\text{C}$ .
2. Storage temperature range:  $-45^{\circ}\text{C} \sim +80^{\circ}\text{C}$ .
3. Humidity range: 10% ~ 90% without moisture condensation.
4. Protection level: Ip32.

**⚠** Do not use under flammable and explosive condition, never put the controller in moist, rainy, dusty, corrosion or electromagnetic interference condition.

**⚠** Self-maintenance is prohibited.

## IX. Protections.

1. Waterproof protection

Waterproof degree:: IP32.

2. Input power limit protection

When the PV power exceeds the rated power, controller will limit the PV power under the value of rated power so as to prevent the controller from being damaged, the controller will charge by limited current.

3. Battery reverse connection protection

Battery reverse connection will not damage the controller but the system will stop working.

4. The voltage of PV input terminal is over value

When the voltage of PV input terminal is over value, controller will shut the PV input automatically.

5. Short circuit protection of PV input terminal

Load short circuit will not damage the controller but controller will stop output.

6. Reverse charge protection at night.

Prevent the battery from discharge at night.

7. TVS lightning protection

8. Over temperature protection

When inside temperature of the controller is over value, the controller will lower charging power or stop charging.

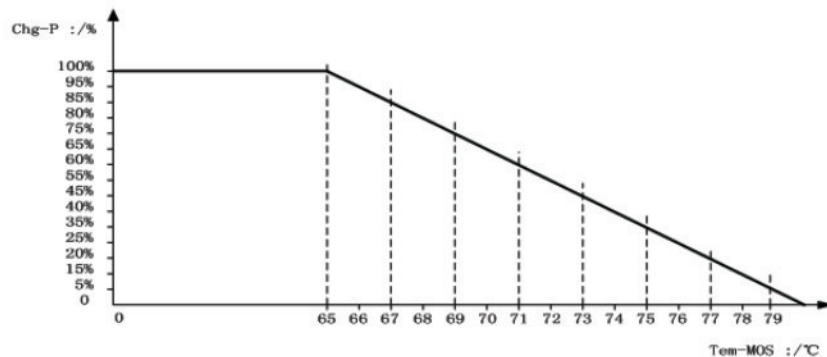

## XI. Fault code.

Fault code	Indication
BAT_LDV	Battery is over discharge
BAT_OVD	The system is over voltage
OVRTMP1	The controller inside is over temperature
OVETMP2	The outside controller is over temperature
P_OVRCRT	The solar panel is over current
P_SHTCRT	The solar panel is short circuit
P_OVP	The solar panel is over voltage
P_SHADOW	The solar panel is shaded
P_EDDY	Reverse current in solar panel
P_WK_OVP	Tracing working voltage exceeds 140V
BAT_SNSR	Fault sampling of outer battery
ERR_485	Abnormal communication of Rs485

## i Parameters.

Marks: n represents  $\times 2/24\text{V}$ ;  $\times 3/36\text{V}$ ;  $\times 4/48\text{V}$ .

Parameters	Value		Adjustable	Default value
Model	SR-MT4860	SR-MT4845		
System voltage	12V/24V/36V/48V Auto			
No-load loss	0.7 W ~ 1.5W			
Max. Input voltage	< 150V			
Rated charging current	60A	45A		
Max. Input power	800W/12V	600W/12V		
	1600W/24V	1200W/24V		
	2400W/36V	1800W/36V		
	3200W/48V	2400W/48V		



Transfer efficiency	≤98%		
MPPT tracing efficiency	>99%		
Over voltage protection	16V~17.0V; ×nV	✓	16.0V
Limited charge voltage	15.5V~16V; ×nV	✓	15.5V
Equalizing charge voltage	15.0~15.5V; ×nV(25°C)	✓	15.2V
Equalizing charge interval	3~30 day	✓	30day
Boost charge voltage	14.0V~15.0V; ×nV(25°C)	✓	14.4V
Boost charge return voltage	12.3V~13.5V; ×nV(25°C)	✓	13.2V
Float charge voltage	13.2V~14.0V; ×nV(25°C)	✓	13.8V
Over discharge return voltage	12.0V ~ 13.0V; ×nV	✓	12.6V
Over discharge voltage	9.8V ~ 11.8V; ×nV	✓	11.0V
Boost charge time	1H ~ 3H	✓	2H
Equalizing charge time	1H ~ 3H	✓	1H
Temperature compensation	-2.0 ~ -5.0 mV/°C/2V	✓	-3.0
Over temperature protection	Yes		
Light controlled open voltage	5V		
Light controlled delay time	5min		
Device address	1 ~ 16	✓	2(从)
Working temperature	-35°C ~ +45°C		
Protection level	IP32		
Weight	4.8 Kg	4.2 Kg	
Max. Wiring dimension	25 mm <sup>2</sup>		
Altitude	≤ 3000m		
Product dimension	318.7*170*128(mm)	86.7*170*128(mm)	

## ii Conversion efficiency

### 1、12V system

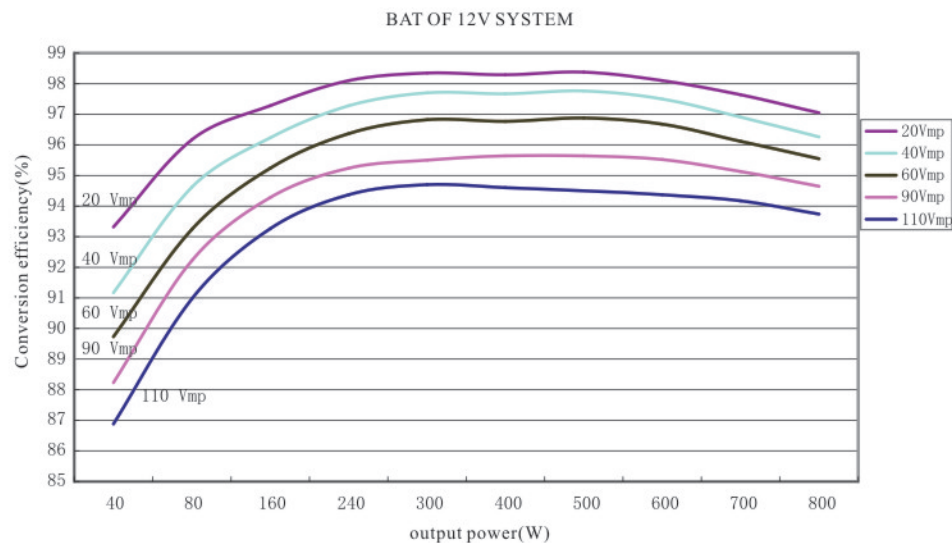

### 2、24V system

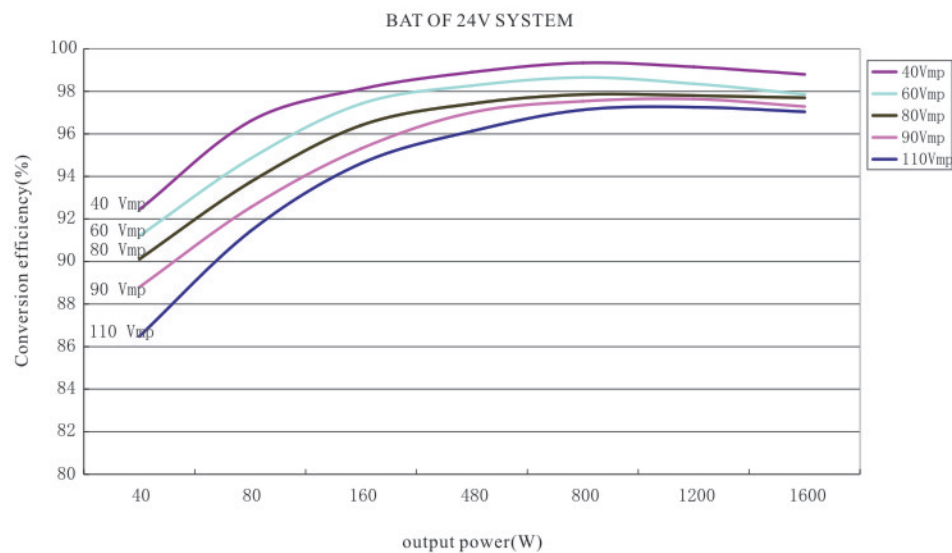

### 3、48V system

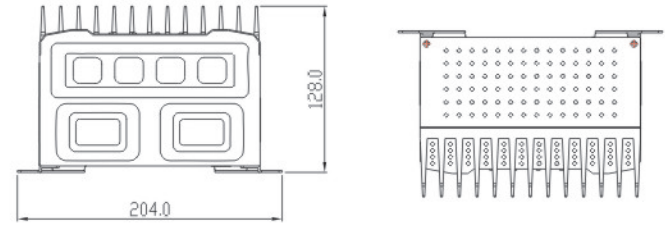
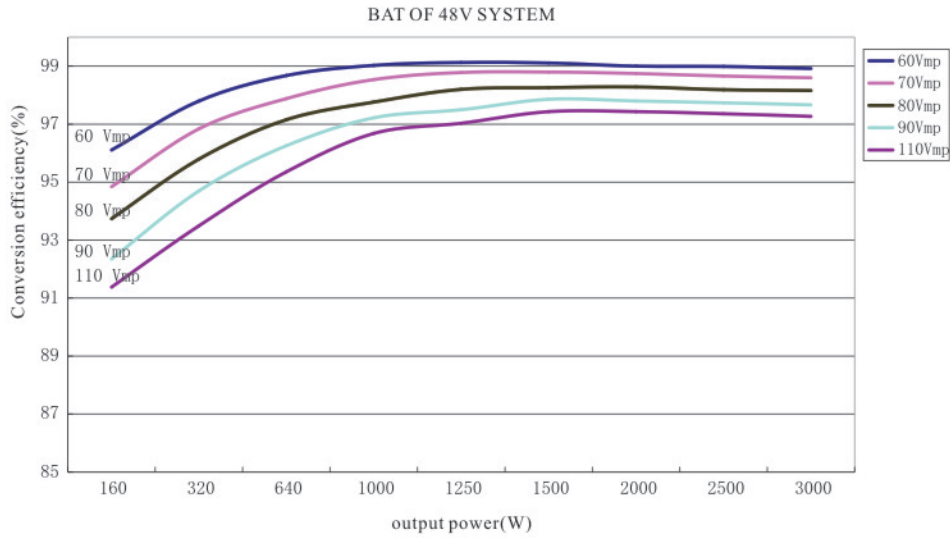

### 2、Dimension of CMP45

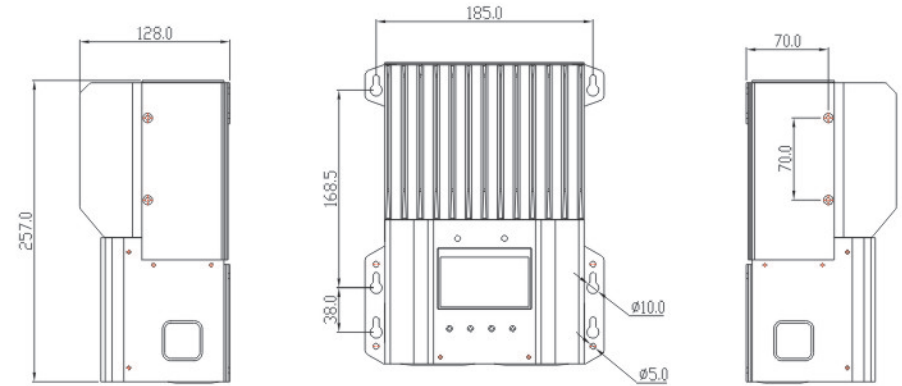

## iii. Dimension.

### 1、Dimension of CMP-60

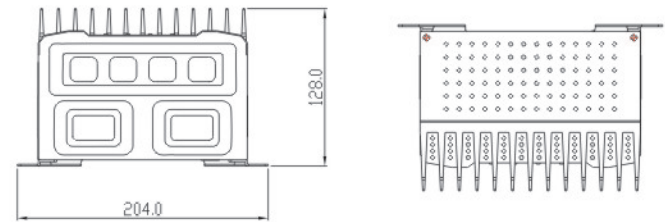
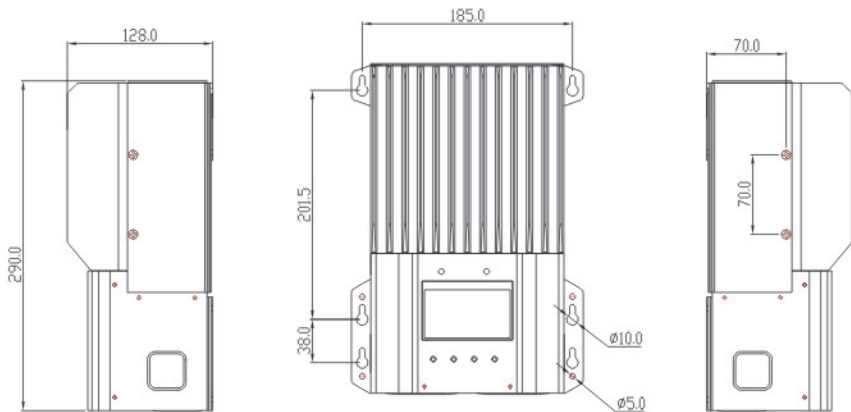

## XII. Warranty

We offer a 1 year limited warranty.

The following cases are not covered under warranty.

1 DC polarity reverse.

The inverter is designed without DC polarity reverse protection. A polarity reverse may severely damage the inverter.

2 Wrong AC wiring

3 Operating in a wet environment.

4 Operating with an undersized generator or generator with unqualified wave form.